



DURABLE SUPERIOR CASTERS®

MANUFACTURER OF CASTERS AND WHEELS 60LB-40,000LB CAPACITY

2023 CATALOG

WHEELS

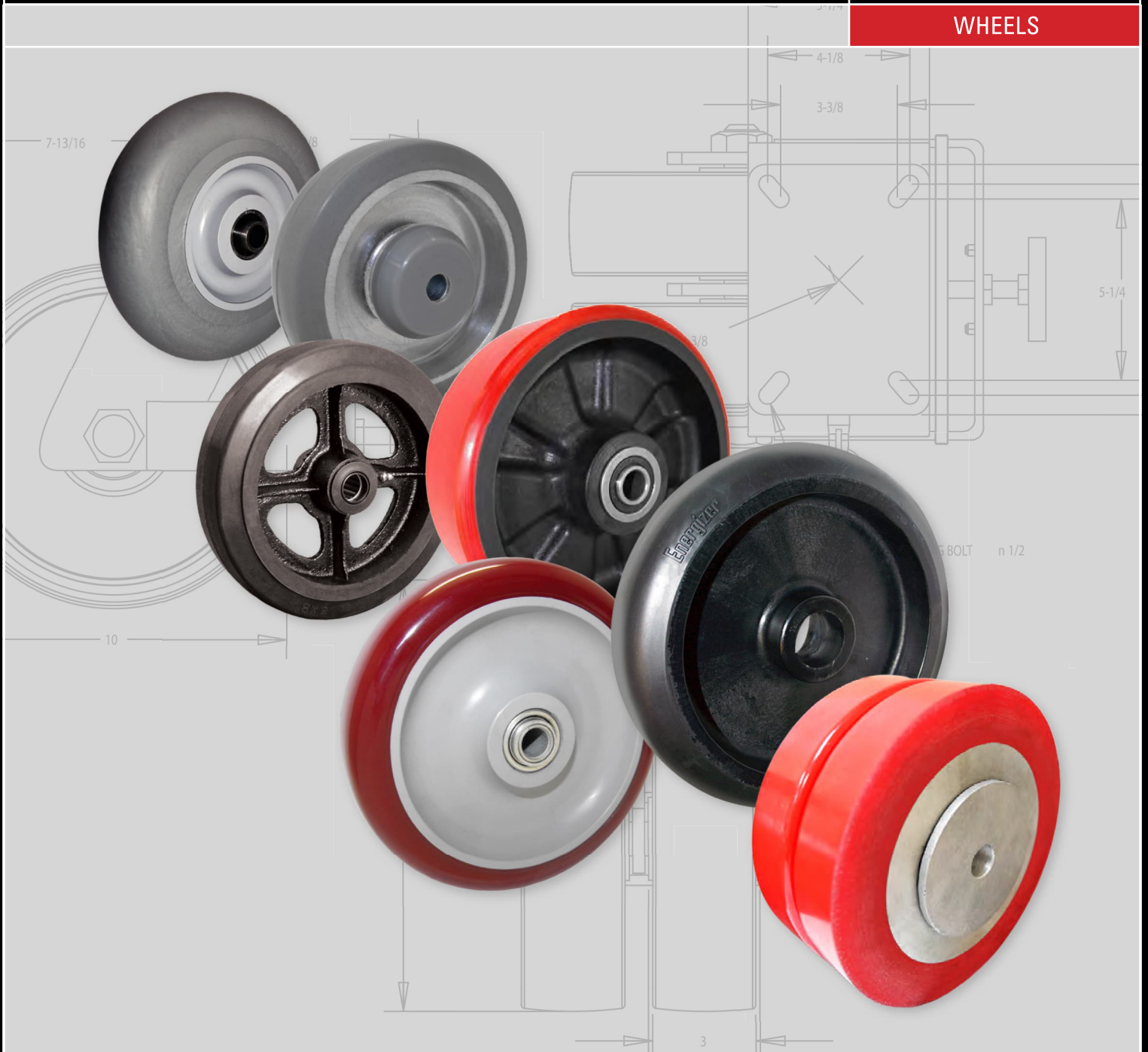

1-800-848-4517

WWW.DURABLECASTERS.COM





CONDUCTIVE CASTERS

CONDUCTIVE SERIES • CAPACITY 700

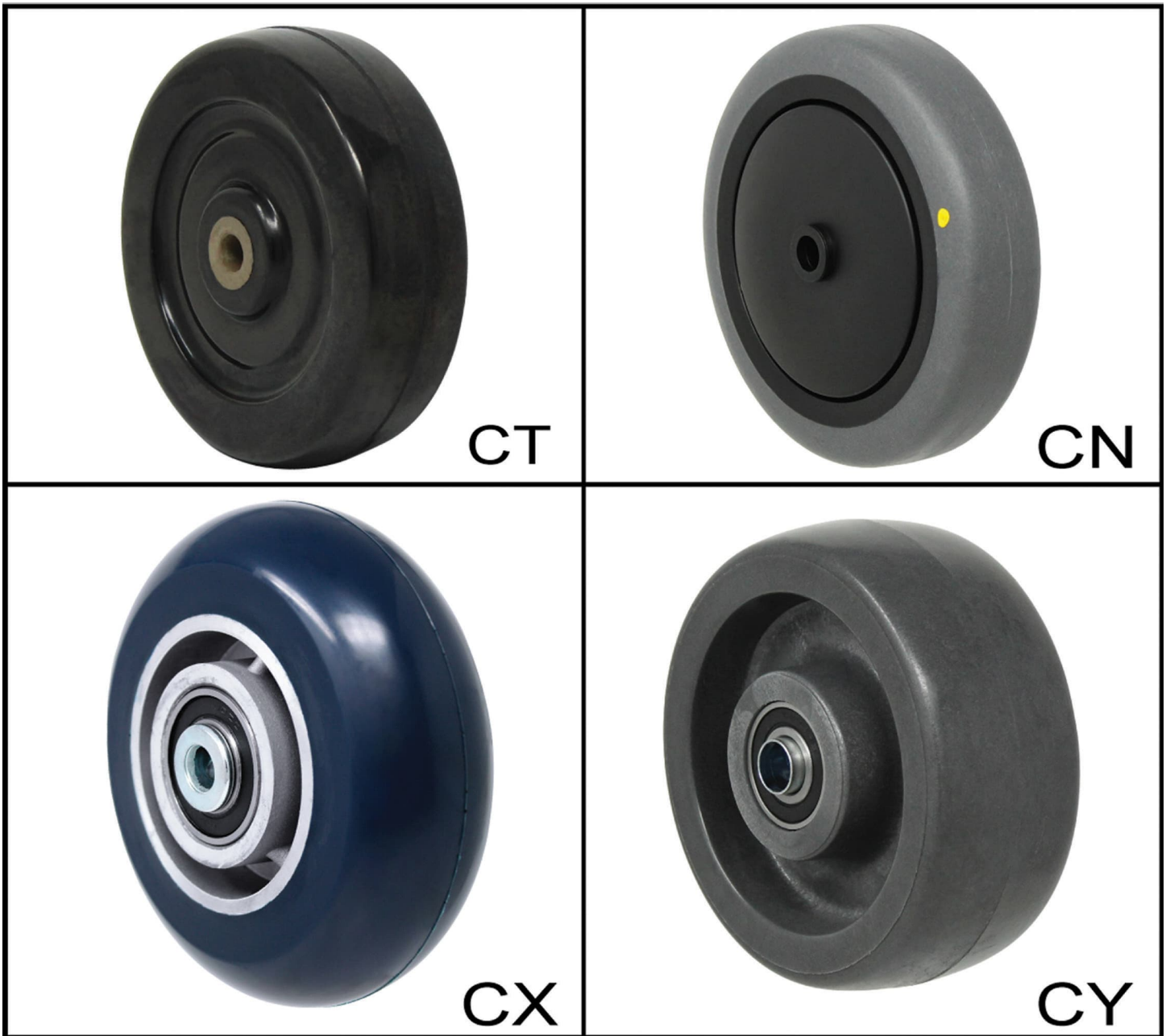

Variety of wheels available for different applications.

CN Thermo rubber wheel

- Shore A 80 +/- 5
- Surface Resistance $> 1 \times 10^3$ but $< 1 \times 10^5$ ohms/square

CU Polyurethane tread interlocked onto a polyolefin core

- Shore A 95 +/- 5
- Surface Resistance $> 1 \times 10^3$ but $< 1 \times 10^5$ ohms/square

CT Solid hard rubber core with cushion rubber tread surface

- Shore A 85 +/- 5
- Surface Resistance $> 1 \times 10^3$ but $< 1 \times 10^5$ ohms/square

CY Nylon wheel

- Shore D 85 for its maximum capacity
- Surface Resistance $> 1 \times 10^3$ but $< 1 \times 10^5$ ohms/square

CX Casted cushion Polyurethane

- Shore A 80 +/- 5
- Surface Resistance $> 1 \times 10^6$ but $< 1 \times 10^9$ ohms/square



Wheel Dia.	Tread Width	Wheel Type	Load Capacity	Bearing Type ##	Caster Part Number		
					Total Lock	SWIVEL	RIGID
3"	1-1/4"	CN-Conductive	225	^Precision		15CN30GH44**YY	16CN30GH44**YY
				SS Precision		15CN30GH4S**YY	16CN30GH4S**YY
3"	1-1/4"	CN-Conductive	225	^Precision	S7CN30GH44**YY	S9CN30GH44**YY	S8CN30GH44**YY
				SS Precision	S7CN30GH4S**YY	S9CN30GH4S**YY	S8CN30GH4S**YY
3"	1-1/4"	CN-Conductive	225	^Precision	7TCN30GH44**YY	73CN30GH44**YY	74CN30GH44**YY
				SS Precision	7TCN30GH4S**YY	73CN30GH4S**YY	74CN30GH4S**YY
3"	1-1/4"	CN-Conductive	225	SS Ball	RTCN30GH2S**YY	RZCN30GH2S**YY	RBCN30GH2S**YY
4"	1-1/4"	CN-Conductive	250	^Precision		15CN40GH44**YY	16CN40GH44**YY
				SS Precision		15CN40GH4S**YY	16CN40GH4S**YY
4"	1-1/4"	CN-Conductive	250	^Precision	S7CN40GH44**YY	S9CN40GH44**YY	S8CN40GH44**YY
				SS Precision	S7CN40GH4S**YY	S9CN40GH4S**YY	S8CN40GH4S**YY
4"	1-1/4"	CN-Conductive	250	^Precision	7TCN40GH44**YY	73CN40GH44**YY	74CN40GH44**YY
				SS Precision	7TCN40GH4S**YY	73CN40GH4S**YY	74CN40GH4S**YY
4"	1-1/4"	CN-Conductive	250	SS Ball	RTCN40GH2S**YY	RZCN40GH2S**YY	RBCN40GH2S**YY
5"	1-1/4"	CN-Conductive	250	S4, 5A		15CN50GH44**YY	16CN50GH44**YY
						15CN50GH4S**YY	16CN50GH4S**YY
5"	1-1/4"	CN-Conductive	250	S4, 5A	S7CN50GH44**YY	S9CN50GH44**YY	S8CN50GH44**YY
					S7CN50GH4S**YY	S9CN50GH4S**YY	S8CN50GH4S**YY
5"	1-1/4"	CN-Conductive	250	S4, 5A	7TCN50GH44**YY	73CN50GH44**YY	74CN50GH44**YY
					7TCN50GH4S**YY	73CN50GH4S**YY	74CN50GH4S**YY
5"	1-1/4"	CN-Conductive	250	S4, 5A	RTCN50GH2S**YY	RZCN50GH2S**YY	RBCN50GH2S**YY
4	2"	CN-Conductive	300	05, S6,B7, 11	B3CN40JH##17YY	B1CN40JH##17YY	B2CN40JH##17YY
					TSCN40JH##17YY	31CN40JH##17YY	32CN40JH##17YY
						S5CN40JH##17YY	S6CN40JH##17YY
						S4CN40JH#317YY	
5"	2"	CN-Conductive	325	05, S6,B7, 11	B3CN50JH##17YY	B1CN50JH##17YY	B2CN50JH##17YY
					TSCN50JH##17YY	31CN50JH##17YY	32CN50JH##17YY
						S5CN50JH##17YY	S6CN50JH##17YY
						S4CN50JH#317YY	
6"	2"	CN-Conductive	410	05, S6,B7, 11	B3CN60JH##17YY	B1CN60JH##17YY	B2CN60JH##17YY
					TSCN60JH##17YY	31CN60JH##17YY	32CN60JH##17YY
						S5CN60JH##17YY	S6CN60JH##17YY
						S4CN60JH#317YY	
8"	2"	CN-Conductive	500	05, S6,B7, 11	B3CN80JH##17YY	B1CN80JH##17YY	B2CN80JH##17YY
					TSCN80JH##17YY	31CN80JH##17YY	32CN80JH##17YY
						S5CN80JH##17YY	S6CN80JH##17YY
						S4CN80JH#317YY	



Wheel Dia.	Tread Width	Wheel Type	Load Capacity	Bearing Type ##	Caster Part Number		
					Total Lock	SWIVEL	RIGID
3"	1-1/4"	CT-Conductive	225	^Precision		15CT30GH44**YY	16CT30GH44**YY
				SS Precision		15CT30GH4S**YY	16CT30GH4S**YY
3"	1-1/4"	CT-Conductive	225	^Precision	S7CT30GH44**YY	S9CT30GH44**YY	S8CT30GH44**YY
				SS Precision	S7CT30GH4S**YY	S9CT30GH4S**YY	S8CT30GH4S**YY
3"	1-1/4"	CT-Conductive	225	^Precision	7TCT30GH44**YY	73CT30GH44**YY	74CT30GH44**YY
				SS Precision	7TCT30GH4S**YY	73CT30GH4S**YY	74CT30GH4S**YY
3"	1-1/4"	CT-Conductive	225	SS Ball	RTCT30GH2S**YY	RZCT30GH2S**YY	RBCT30GH2S**YY
4"	1-1/4"	CT-Conductive	250	^Precision		15CT40GH44**YY	16CT40GH44**YY
				SS Precision		15CT40GH4S**YY	16CT40GH4S**YY
4"	1-1/4"	CT-Conductive	250	^Precision	S7CT40GH44**YY	S9CT40GH44**YY	S8CT40GH44**YY
				SS Precision	S7CT40GH4S**YY	S9CT40GH4S**YY	S8CT40GH4S**YY
4"	1-1/4"	CT-Conductive	250	^Precision	7TCT40GH44**YY	73CT40GH44**YY	74CT40GH44**YY
				SS Precision	7TCT40GH4S**YY	73CT40GH4S**YY	74CT40GH4S**YY
4"	1-1/4"	CT-Conductive	250	SS Ball	RTCT40GH2S**YY	RZCT40GH2S**YY	RBCT40GH2S**YY
5"	1-1/4"	CT-Conductive	250	S4, 5A		15CT50GH44**YY	16CT50GH44**YY
						15CT50GH4S**YY	16CT50GH4S**YY
5"	1-1/4"	CT-Conductive	250	S4, 5A	S7CT50GH44**YY	S9CT50GH44**YY	S8CT50GH44**YY
					S7CT50GH4S**YY	S9CT50GH4S**YY	S8CT50GH4S**YY
5"	1-1/4"	CT-Conductive	250	S4, 5A	7TCT50GH44**YY	73CT50GH44**YY	74CT50GH44**YY
					7TCT50GH4S**YY	73CT50GH4S**YY	74CT50GH4S**YY
5"	1-1/4"	CT-Conductive	250	S4, 5A	RTCT50GH2S**YY	RZCT50GH2S**YY	RBCT50GH2S**YY
3"	1-1/4"	CY-Conductive	225	^Precision		15CY30GH44**YY	16CY30GH44**YY
				SS Precision		15CY30GH4S**YY	16CY30GH4S**YY
3"	1-1/4"	CY-Conductive	225	^Precision	S7CY30GH44**YY	S9CY30GH44**YY	S8CY30GH44**YY
				SS Precision	S7CY30GH4S**YY	S9CY30GH4S**YY	S8CY30GH4S**YY
3"	1-1/4"	CY-Conductive	225	^Precision	7TCY30GH44**YY	73CY30GH44**YY	74CY30GH44**YY
				SS Precision	7TCY30GH4S**YY	73CY30GH4S**YY	74CY30GH4S**YY
3"	1-1/4"	CY-Conductive	225	SS Ball	RTCY30GH2S**YY	RZCY30GH2S**YY	RBCY30GH2S**YY
4"	1-1/4"	CY-Conductive	250	^Precision		15CY40GH44**YY	16CY40GH44**YY
				SS Precision		15CY40GH4S**YY	16CY40GH4S**YY
4"	1-1/4"	CY-Conductive	250	^Precision	S7CY40GH44**YY	S9CY40GH44**YY	S8CY40GH44**YY
				SS Precision	S7CY40GH4S**YY	S9CY40GH4S**YY	S8CY40GH4S**YY
4"	1-1/4"	CY-Conductive	250	^Precision	7TCY40GH44**YY	73CY40GH44**YY	74CY40GH44**YY
				SS Precision	7TCY40GH4S**YY	73CY40GH4S**YY	74CY40GH4S**YY
4"	1-1/4"	CY-Conductive	250	SS Ball	RTCY40GH2S**YY	RZCY40GH2S**YY	RBCY40GH2S**YY
5"	1-1/4"	CY-Conductive	250	S4, 5A		15CY50GH44**YY	16CY50GH44**YY
						15CY50GH4S**YY	16CY50GH4S**YY
5"	1-1/4"	CY-Conductive	250	S4, 5A	S7CY50GH44**YY	S9CY50GH44**YY	S8CY50GH44**YY
					S7CY50GH4S**YY	S9CY50GH4S**YY	S8CY50GH4S**YY
5"	1-1/4"	CY-Conductive	250	S4, 5A	7TCY50GH44**YY	73CY50GH44**YY	74CY50GH44**YY
					7TCY50GH4S**YY	73CY50GH4S**YY	74CY50GH4S**YY
5"	1-1/4"	CY-Conductive	250	S4, 5A	RTCY50GH2S**YY	RZCY50GH2S**YY	RBCY50GH2S**YY
4"	2"	CY-Conductive	300	05, S6,B7, 11	B3CY40JH##17YY	B1CY40JH##17YY	B2CY40JH##17YY
					TSCY40JH##17YY	31CY40JH##17YY	32CY40JH##17YY
4"	2"	CY-Conductive	300	05, S6,B7, 11		S5CY40JH##17YY	S6CY40JH##17YY
						S4CY40JH#317YY	
5"	2"	CY-Conductive	325	05, S6,B7, 11	B3CY50JH##17YY	B1CY50JH##17YY	B2CY50JH##17YY
					TSCY50JH##17YY	31CY50JH##17YY	32CY50JH##17YY
5"	2"	CY-Conductive	325	05, S6,B7, 11		S5CY50JH##17YY	S6CY50JH##17YY
						S4CY50JH#317YY	
6"	2"	CY-Conductive	410	05, S6,B7, 11	B3CY60JH##17YY	B1CY60JH##17YY	B2CY60JH##17YY
					TSCY60JH##17YY	31CY60JH##17YY	32CY60JH##17YY
6"	2"	CY-Conductive	410	05, S6,B7, 11		S5CY60JH##17YY	S6CY60JH##17YY
						S4CY60JH#317YY	
8"	2"	CY-Conductive	500	05, S6,B7, 11	B3CY80JH##17YY	B1CY80JH##17YY	B2CY80JH##17YY
					TSCY80JH##17YY	31CY80JH##17YY	32CY80JH##17YY
8"	2"	CY-Conductive	500	05, S6,B7, 11		S5CY80JH##17YY	S6CY80JH##17YY
						S4CY80JH#317YY	

Wheel Dia.	Tread Width	Wheel Type	Load Capacity	Bearing Type ##	Caster Part Number		
					Total Lock	SWIVEL	RIGID
4	2"	CX-Conductive	500	05, S6,B7, 11	B3CX40JH##17YY	B1CX40JH##17YY	B2CX40JH##17YY
4	2"	CX-Conductive	500	05, S6,B7, 11	TSCX40JH##17YY	31CX40JH##17YY	32CX40JH##17YY
4	2"	CX-Conductive	500	05, S6,B7, 11		S5CX40JH##17YY	S6CX40JH##17YY
4	2"	CX-Conductive	500	05, S6,B7, 11		S4CX40JH#317YY	
5"	2"	CX-Conductive	540	05, S6,B7, 11	B3CX50JH##17YY	B1CX50JH##17YY	B2CX50JH##17YY
5"	2"	CX-Conductive	540	05, S6,B7, 11	TSCX50JH##17YY	31CX50JH##17YY	32CX50JH##17YY
5"	2"	CX-Conductive	540	05, S6,B7, 11		S5CX50JH##17YY	S6CX50JH##17YY
5"	2"	CX-Conductive	540	05, S6,B7, 11		S4CX50JH#317YY	
6"	2"	CX-Conductive	600	05, S6,B7, 11	B3CX60JH##17YY	B1CX60JH##17YY	B2CX60JH##17YY
6"	2"	CX-Conductive	600	05, S6,B7, 11	TSCX60JH##17YY	31CX60JH##17YY	32CX60JH##17YY
6"	2"	CX-Conductive	600	05, S6,B7, 11		S5CX60JH##17YY	S6CX60JH##17YY
6"	2"	CX-Conductive	600	05, S6,B7, 11		S4CX60JH#317YY	
8"	2"	CX-Conductive	700	05, S6,B7, 11	B3CX80JH##17YY	B1CX80JH##17YY	B2CX80JH##17YY
8"	2"	CX-Conductive	700	05, S6,B7, 11	TSCX80JH##17YY	31CX80JH##17YY	32CX80JH##17YY
8"	2"	CX-Conductive	700	05, S6,B7, 11		S5CX80JH##17YY	S6CX80JH##17YY
8"	2"	CX-Conductive	700	05, S6,B7, 11		S4CX80JH#317YY	

Antistatic Shopping Cart replacement wheel

- Molecule is mixed into the resins of the polyurethane tread and polyolefin core to ensure the entire wheel is 100% antistatic
- High quality ball bearings with I.D. 5/16"

TU50GP50





CONQUER™ - Round Tread Polyurethane on Aluminum Core

- Waffle hub design for 6" dia. And 8" dia. for the heavy loading
- Completed with Precision ball bearings, top hat and spacers
- Precision ball bearings with top hat spacers
- Temperature Range -40°F to +180°F
- Ergonomic performance
- Impact Resistance



Conquer™ 95A					
Wheel Diameter	Tread Width	Hub Length	Load Capacity	Bore I.D.	Part Number
4"	2"	2-7/16"	1300	1/2"	CQ40JL63
5"	2"	2-7/16"	1500	1/2"	CQ50JL64
6"	2"	2-7/16"	1700	1/2"	CQ60JL64
8"	2"	2-7/16"	2000	1/2"	CQ80JL64
Conquer™ 85A					
Wheel Diameter	Tread Width	Hub Length	Load Capacity	Bore I.D.	Part Number
4"	2"	2-7/16"	1300	1/2"	CQ40JM63
5"	2"	2-7/16"	1500	1/2"	CQ50JM64
6"	2"	2-7/16"	1700	1/2"	CQ60JM64
8"	2"	2-7/16"	2000	1/2"	CQ80JM64
Conquer™ 55D					
Wheel Diameter	Tread Width	Hub Length	Load Capacity	Bore I.D.	Part Number
4"	2"	2-7/16"	1300	1/2"	CQ40JG63
5"	2"	2-7/16"	1500	1/2"	CQ50JG64
6"	2"	2-7/16"	1700	1/2"	CQ60JG64
8"	2"	2-7/16"	2000	1/2"	CQ80JG64
10"	2"	2-7/16"	2000	1/2"	CQ10JM64

D-POLYON™ - Round Tread Polyurethane on Aluminum Core

- Polyurethane tread chemically bonded to Aluminum core
- Completed with Precision Bearings, top hat and spacers
- Temperature Range -40°F to 180°F
- Durometer Shore D65(+/-5)
- Donut pattern tread
- Blue color



Wheel Diameter	Tread Width	Hub Length	Load Capacity	Bore I.D.	Part Number
6"	2"	2-7/16"	1000	1/2"	UD60JL64
8"	2"	2-7/16"	1200	1/2"	UD80JL64

CQ,UD WHEELS • CAPACITY 2000

Champion™ - Ultra-Flex polyurethane on Aluminum Core

- 1-3/16" Thick ultra-flex compound polyurethane elastomer tread, chemically bonded to Aluminum core
- Low rolling resistance over debris and small obstructions
- Completed with Precision ball bearings and top hat spacer
- Great for manual or power applications
- Temperature range: -40°F to 180°F
- Durometer: Shore A 80(+/- 5)
- Color: Green and Red
- High impact strength



Wheel Diameter	Tread Width	Hub Length	Bore I.D.	Load Capacity	Tread Color	Part Number
4"	2"	2-7/16"	1/2"	1000	Red	CP40JR63
					Green	CP40JN63
5"	2"	2-7/16"	1/2"	1200	Red	CP50JR64
					Green	CP50JN64
6"	2"	2-7/16"	1/2"	1200	Red	CP60JR64
					Green	CP60JN64
8"	2"	2-7/16"	1/2"	2000	Red	CP80JR64
					Green	CP80JN64
8"	2-1/2"	3-1/2"	3/4"	2000	Green	CP80QN67

ULTRAFLEX™ - Ergonomic Polyurethane on Aluminum Core

- Ultraflex is uniquely formulated for the best ergonomic push/pull after set and in-line operation
- Completed with precision ball bearings and top hat spacers
- Extra thick PU tread for best cushioned ride
- Temperature Range: -50°F to 180°F
- Color options: Orange and Maroon
- Durometer Shore A 80 (+/- 5)



Wheel Diameter	Tread Width	Hub Length	Load Capacity	Bore I.D.	Color	Part Number
3"	1-1/4"	1-11/16"	400	3/8"	Orange	UX30GO62
4"	1-1/4"	1-11/16"	450	3/8"	Orange	UX40GO62
5"	1-1/4"	1-11/16"	500	3/8"	Orange	UX50GO62
4"	2"	2-7/16"	900	1/2"	Orange	UX40JO63
					Maroon	UX40JM63
5"	2"	2-7/16"	900	1/2"	Orange	UX50JO64
					Maroon	UX50JM64
6"	2"	2-7/16"	1000	1/2"	Orange	UX60JO64
					Maroon	UX60JM64
8"	2"	2-7/16"	1200	1/2"	Orange	UX80JO64
					Maroon	UX80JM64
8"	3"(Flat)	3-1/2"	1500	3/4"	Orange(Cast Iron Core)	UX80LO5P



POLYFLEXON® on Aluminum Core

- Uniquely formulated “Flex Compound” Polyurethane elastomer is chemically and mechanically bonded to heavy aluminum core
- Completed with Precision bearings, top hat and spacers
- Temperature Range -40°F to 180°F
- Durometer Shore A 95 (+/- 5)
- Donut pattern tread

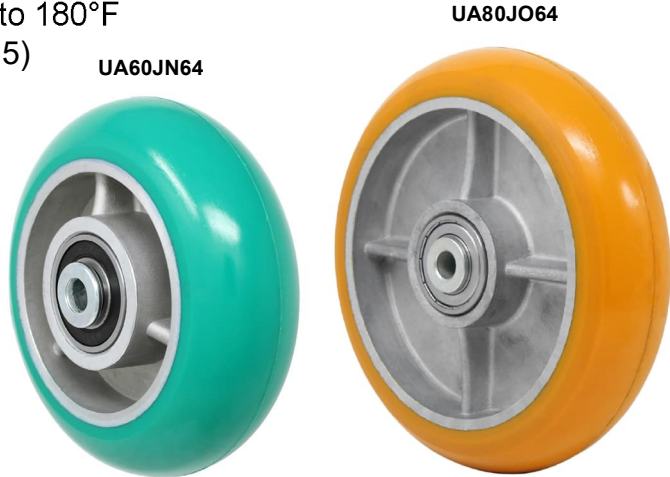

Wheel Diameter	Tread Width	Hub Length	Load Capacity	Bore I.D.	Color	Part Number
4"	2"	2-7/16"	900	1/2"	Green	UA40JN63
					Orange	UA40JO63
5"	2"	2-7/16"	900	1/2"	Green	UA50JN64
					Orange	UA50JO64
6"	2"	2-7/16"	1000	1/2"	Green	UA60JN64
					Orange	UA50JO64
8"	2"	2-7/16"	1200	1/2"	Green	UA80JN64
					Orange	UA80JO64

POLYFLEXON® - Round Tread Polyurethane on Cast Iron Core

- Uniquely Formulated “Flex Compound” Polyurethane elastomer is chemically bonded to heavy cast iron core
- Multiple options of bearings for different application
- Standard Color: Red tread on black core
- Temperature range: -40° F to 180° F
- Durometer Shore A 95(+/-5)
- Donut pattern tread



Wheel Diameter	Tread Width	Hub Length	Load Capacity	Bore I.D.	Replace ** with desired bearing code					Part Number
					Annular Brg.	Prec. Ball Brg.	Roller Brg.	Delrin Brg.	Bronze Bushing	
4"	2"	2-3/16"	700	1-3/16"						RP40JK84
		2-7/16"		1/2"	48	60				RP40JK**
				5/8"			02	56, 12		
				3/4"			04, 09	57, 11	B1, B7	
5"	2"	2-3/16"	800	1-3/16"						RP50JK84
		2-7/16"		1/2"	48	60				RP50JK**
				5/8"			02	56, 12		
				3/4"			04, 09	57, 11	B1, B7	
6"	2"	2-3/16"	900	1-3/16"						RP60JK84
		2-7/16"		1/2"	48	60				RP60JK**
				5/8"			02	56, 12		
				3/4"			04, 09	57, 11	B1, B7	
6"	2"	2-3/16"	900	1/2"						RP60JK63
8"	2"	2-3/16"	1000	1/2"						RP80JK63

*Including Top Hats



DW Wheels - Dual Flat Tread Polyurethane Wheels

- Designed to replace traditional single wheels for better maneuvering while not widening the footprint and swivel radius
- Multiple choices of different hardness and grade Polyurethane for different application
- Avoiding severe damage from impact caused by triple or quadruple narrow wheels
- Aluminum core for 1" wide, Ductile iron cores for 1.5" and 2" wide
- Heavy duty precision bearings reduce rolling resistance
- Temperature range -40° F to +180° F
- Better load distribution on sharp turns
- Extended life and performance
- Lower initial start force
- Easier to turn



DW60JBT3



DW60JRT3



DW60JLT3



DW WHEELS • CAPACITY 7000

Wheel dia.	Tread Width	Hub Length	Load Capacity	Bore ID	Hub Material	Bearings	Part Number	Color	Durometer
4"	1" x 2	2-7/16"	470	1/2"	Aluminum	6207 x 2	DW40JLT3	BLACK	Shore A 70-75
			650				DW40JRT3	RED	Shore A 80-85
			960				DW40JBT3	BLUE	Shore A 90-95
			1000				DW40JGT3	GRAY	Shore D 65
5"	1" x 2	2-7/16"	550	1/2"	Aluminum	6702 x 2	DW50JLT3	BLACK	Shore A 70-75
			750				DW50JRT3	RED	Shore A 80-85
			1160				DW50JBT3	BLUE	Shore A 90-95
			1200				DW50JGT3	GRAY	Shore D 65
6"	1" x 2	2-7/16"	700	1/2"	Aluminum	6207 x 2	DW60JLT3	BLACK	Shore A 70-75
			960				DW60JRT3	RED	Shore A 80-85
			1400				DW60JBT3	BLUE	Shore A 90-95
			1440				DW60JGT3	GRAY	Shore D 65
8"	1" x 2	2-7/16"	750	1/2"	Aluminum	6207 x 2	DW80JLT3	BLACK	Shore A 70-75
			1100				DW80JRT3	RED	Shore A 80-85
			1600				DW80JBT3	BLUE	Shore A 90-95
			1700				DW80JGT3	GRAY	Shore D 65
6"	1.5" x 2	3-1/2"	3500	3/4"	Cast Iron	6206*4	DW60LBT4	BLUE	Shore A 90-95
			3900				DW60LGT4	GRAY	Shore D 65
8"	1.5" x 2	3-1/2"	4000	3/4"	Cast Iron	6206*4	DW80LBT4	BLUE	Shore A 90-95
			4500				DW80LGT4	GRAY	Shore D 65
10"	1.5" x 2	3-1/2"	4600	3/4"	Cast Iron	6206*4	DW10LBT4	BLUE	Shore A 90-95
			5200				DW10LGT4	GRAY	Shore D 65
6"	1.5" x 2	3-1/2"	3500	1"	Cast Iron	6207*4	DW60LBT5	BLUE	Shore A 90-95
			3900				DW60LGT5	GRAY	Shore D 65
8"	1.5" x 2	3-1/2"	4000	1"	Cast Iron	6207*4	DW80LBT5	BLUE	Shore A 90-95
			4500				DW80LGT5	GRAY	Shore D 65
10"	1.5" x 2	3-1/2"	4600	1"	Cast Iron	6207*4	DW10LBT5	BLUE	Shore A 90-95
			5200				DW10LGT5	GRAY	Shore D 65
8"	2" x 2"	4-9/16"	4700	1-1/4"	Ductile Iron	6207*4	DW80NBT6	BLUE	Shore A 90-95
			5200				DW80NGT6	GRAY	Shore D 65
10"	2" x 2"	4-9/16"	6400	1-1/4"	Ductile Iron	6207*4	DW10NBT6	BLUE	Shore A 90-95
			7000				DW10NGT6	GRAY	Shore D 65
6"	1.5" x 2	3-1/2"	1300	3/4"	Solid PU	6205	SP60LRT3	RED	Shore D65



DW Wheels - Dual Round Tread Polyurethane Wheels

DW80XRT3

DW80YGT5



DW WHEELS • CAPACITY 7000

Wheel dia.	Tread Width	Hub Length	Load Capacity	Bore ID	Hub Material	Bearings	Part Number	Color	Durometer
6"	1" x 2	2-7/16"	700	1/2"	Aluminum	6207 x 2	DW60XLT3	BLACK	Shore A 70-75
			960				DW60XRT3	RED	Shore A 80-85
			1440				DW60XGT3	GRAY	Shore D 65
8"	1" x 2	2-7/16"	1100	1/2"	Aluminum	6207 x 2	DW80XRT3	RED	Shore A 80-85
			1700				DW80X+T3	D=Black G=Gray	Shore D 65
6"	1.5" x 2	3-1/2"	3900	1"	Cast Iron	6206 x 4	DW60YGT5	GRAY	Shore D 65
8"	1.5" x 2	3-1/2"	3000	3/4"	Cast Iron	6206 x 4	DW80YRT4	RED	Shore A 80-85
			4500				DW80YGT4	GRAY	Shore D 65
10"	1.5" X 2	3-1/2"	4600	3/4"	Cast Iron	6206 x 4	DW10YRT4	RED	Shore A 80-85
12"	1.5" x 2	3-1/2"	3500	3/4"	Cast Iron	6206 x 4	DW12YRT4	RED	Shore A 80-85
8"	2" x 2"	4-9/16"	4700	1-1/4"	Ductile Iron	6207 x 4	DW80ZBT6	BLUE	Shore A 90-95
			5200				DW80ZGT6	GRAY	Shore D 65
10"	2" x 2"	4-9/16"	6400	1-1/4"	Ductile Iron	6207 x 4	DW10ZBT6	BLUE	Shore A 90-95
			7000				DW10ZGT6	GRAY	Shore D 65



ULTRA-POLY™

- 3/4" Thick PU on heavy-duty cast-iron core for higher load capacity with longer life
- Variety of bearing options for optimum performance in different application
- Durometer Shore D 60 (+/- 5)
- Temperature range: -40° F to 180°F



EX10LG69



EX10LK71P



EX WHEELS • CAPACITY 6500

Wheel Diameter	Tread Width	Hub Length	Load Capacity	Bore I.D.	Roller Brg.	Prec. Ball Brg.	Tapered Brg.	Bronze Brg.	Part #
6"	3"	3-1/4"	3000	1-15/16"					EX60LG85
		3-1/2"		3/4"	24	65", 69	70		EX60LG**
				1"	26	67", R1	71	B8	
8"	3"	3-1/4"	3500	1-15/16"					EX80LG85
		3-1/2"		3/4"	24	65", 69	70		EX80LG**
				1"	26	67", R1	71	B8	
8"	4"	4-1/4"	4000	2-7/16"					EX80NG86
		4-9/16"		1-1/4"	31	68"	71		EX80NG**
				1-1/2"	33		74		
10"	3"	3-1/4"	4000	1-15/16"					EX10LG85
		3-1/2"		3/4"	24	65", 69	70		EX10LG**
				1"	26	67", R1	71	B8	
10"	4"	4-1/4"	5500	2-7/16"					EX10NG86
		4-9/16"		1-1/4"	31	68"	71		EX10NG**
				1-1/2"	33		74		
12"	3"	3-1/4"	5000	1-15/16"					EX12LG85
		3-1/2"		3/4"	24	65", 69	70		EX12LG**
				1"	26	67", R1	71	B8	
12"	4"	4-1/4"	6500	2-7/16"					EX12NG86
		4-9/16"		1-1/4"	31	68"	71		EX12NG**
				1-1/2"	33		74		

~ Include Top Hats



ERGOLASTOMER™

- Super strength solid casted polyurethane elastomer mechanically locked with glass filled nylon bearing collar
- Variety of bearing options for optimal performance at different applications
- Color: Gray with black bearing collar
- Temperature range: -50° to 180° F
- Durometer: Shore 65(+/-5)



HU80LI65

HU60JI92

HU60JI64



HU WHEELS • CAPACITY 3200

Wheel Diameter	Tread Width	Hub Length	Load Capacity	Bore I.D.	Replace ** with desired bearing code					Part Number	
					Roller Brg.	Stainless Roller Brg.	Prec. Ball Brg.	Stainless Pre. Ball Brg.	Delrin Brg.		
4"	2"	2-3/16"	1000	1-3/16"						HU40JI84	
		2-7/16"		1/2"	92	9S	64~	6S, 76~	56, 12	HU40JI**	
				5/8"	02						
				3/4"	04, 09	05			57, 11		
5"	2"	2-3/16"	1400	1-3/16"						HU50JI84	
		2-7/16"		1/2"	92	9S	64~	6S, 76~	56, 12	HU50JI**	
				5/8"	02						
				3/4"	04, 09	05			57, 11		
6"	2"	2-3/16"	1700	1-3/16"						HU60JI84	
		2-7/16"		1/2"	92	9S	64~	6S, 76~	56, 12	HU60JI**	
				5/8"	02						
				3/4"	04, 09	05			57, 11		
6"	2-1/2"	2-3/4"	2200	3/4"			65~	77~		HU60KI**	
8"	2"	2-3/16"	2000	1-3/16"							HU80JI84
		2-7/16"		1/2"	92	9S	64~	6S, 76~	56, 12	HU80JI**	
				5/8"	02						
				3/4"	04, 09	05			57, 11		
8"	2-1/2"	2-3/4"	2300	3/4"			65~	77~		HU80KI**	
8"	3"	3-1/4"	3000	3/4"			65~	7L~		HU80L**	
10"	3"	3-1/4"	3200	3/4"			65~	7L~		HU10LI**	

90, 92 & 9S Include Spanner

~ Include top hats.



MEGAPOLY™ - TITAN™ Polyurethane Wheel

- Megapoly™ slows down internal heat that builds up from high loads and significantly increases in its load capacity and life span
- Tread thickness: 1/2" for 2" tread width wheels, and 1" for 3" and wider tread width wheel
- Variety of bearing options for extended applications
- Extra numbers of bearings for maximum load capacity
- Temperature range: -40° F to 180°F
- Durometer Shore A 95



PX12LD7P

PX12LO5P



PX WHEELS • CAPACITY 10000

Wheel Diameter	Tread Width	Hub Length	Load Capacity	Bore I.D.	Replace ** with desired bearing code				Part #
					Prec. Ball Brg.™	Tapered Roller Brg.	Bronze Brg.	Roller Brg.	
6"	2"	2-7/16"	2000	1/2"	4P(6203 x 2)				PX60JO63
6"	3"	3-1/2"	4000	3/4"	5P(6205 x 4)	70			PX60LO**
				1"		71	B8		
6"	5"	5-1/2"	6500	1-5/16"	CSB207-21				PX60525CSB207-D
8"	2"	2-7/16"	2000	1/2"	63				PX80JO63
8"	3"	3-1/2"	5500	3/4"	5P(6205 x 4)	70			PX80LO**
				1"	7P(6207 x 4)	71	B8		
8"	4"	4-9/16"	6500	1-1/4"	8P(6208 x 4)	74			PX80NO**
10"	3"	3-1/2"	6000	1"	7P(6207 x 4)	7A			PX10LO**
			6000	1-1/4"		74			
10"	4"	4-9/16"	7000	1-1/4"	8P(6208 x 4)	74			PX10NO**
10"	5"	5-1/2"	8000	1-1/4"	8P(6208 x 4)	74			PX10OO**
12"	3"	3-1/2"	6500	3/4"	5P(6205 x 4)	70			PX12LO**
			6500	1"	7P(6207 x 4)	71	B8		
			6000	3/4"	69			24	
			6000	1"	71P			26	
12"	3"(Crown)	3-1/2"	6000	1	7P(6207 x 4)				PX12LD78
12"	4	4-9/16"	8000	1-1/4"	8P(6208 x 4)	74			PX12NO**
14"	4	4-9/16"	7500	1-1/4"		74			PX14NO74
16"	3"	3-1/2"	7000	1"	7P(6207 x 4)				PX16LO7P
16"	5"	5-1/2"	10000	1-1/4"	8P(6208 x 4)	74			PX16OO**

™ Include Top Hat



DURALASTOMER

- Standard color: Blue. Different color is available, please consult factory.
- Solid casted polyurethane elastomer for its maximum strength.
- Smooth and crown surface and low rolling resistance
- Temperature Range: -50°F to 180° F
- Durometer: Shore D 60(+/- 5)

SU WHEELS • CAPACITY 1000

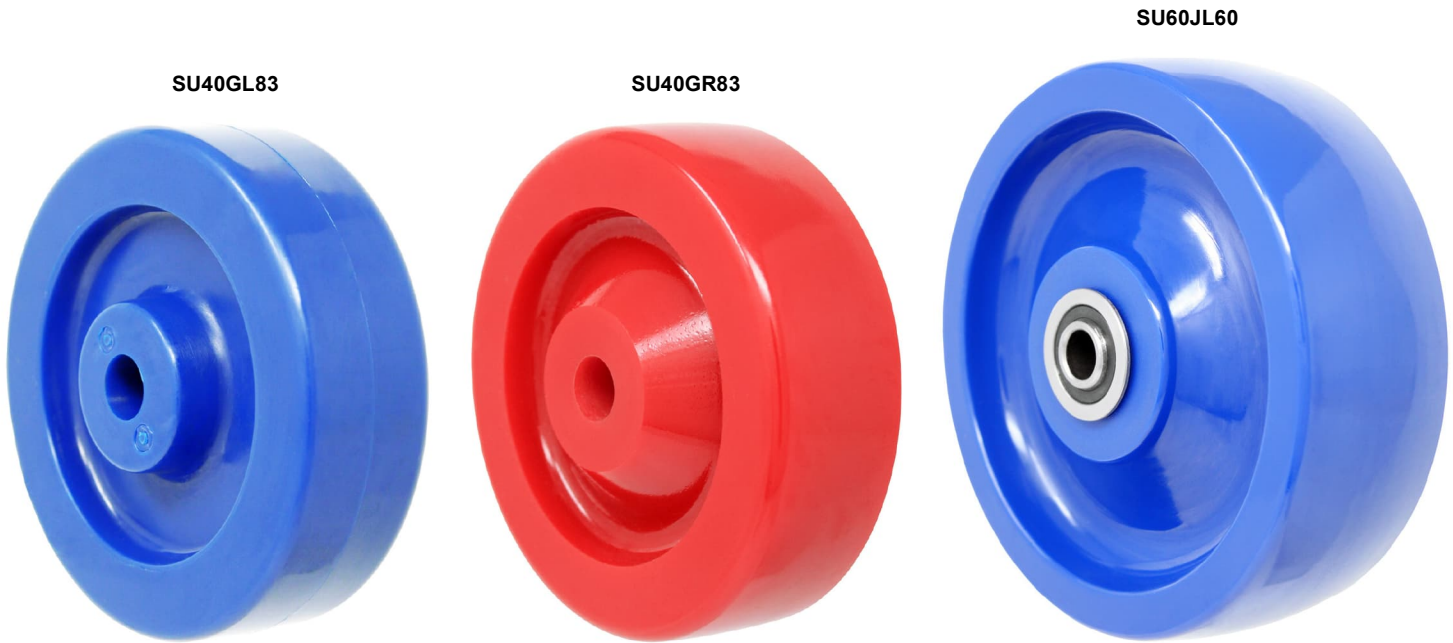

Wheel Diameter	Tread Width	Hub Length	Load Capacity	Bore I.D.	Replace ** with desired bearing code					Part Number
					Roller Brg.	Stainless Roller Brg.	Prec. Ball Brg.	Stainless Prec. Ball Brg.	Delrin Brg.	
3"	1-1/4"(Blue)	1-9/16"	300	1/2"						SU30GL83
				3/8"						SU30GL90
	1-1/4"(Red)			1/2"						SU30GR83
				3/8"						SU30GR90
4"	1-1/4"(Blue)	1-9/16"	400	1/2"						SU40GL83
				3/8"						SU40GL90
	1-1/4"(Red)			1/2"						SU40GR83
				3/8"						SU40GR90
4"	2"	2-3/16"	750	1-3/16"						SU40JL84
		2-7/16"		1/2"	92	9S	60,63	6S	56, 12	SU40JL**
				3/4"	09	05			57, 11	
5"	1-1/4"	1-9/16"	700	1/2"						SU50GL83
		3/8"							SU50GL90	
	1-1/2"	1-7/8"	700	1-3/16"						SU50HL84
5"	2"	2-3/16"	800	1-3/16"						SU50JL84
		2-7/16"		1/2"	92	9S	60,63	6S	56, 12	SU50JL**
				3/4"	09	05			57, 11	
6"	1-1/2"	1-5/8"	600	1-3/16"						SU60HL84
		1-7/8"		1/2"	92		6M		56, 12	SU60HL**
				3/4"	03				57, 11	
	2"	2-3/16"	900	1-3/16"						SU60JL84
		2-7/16"		1/2"	92	9S	60, 63 [~]	6S, 72 [~]	56, 12	SU60JL**
3/4"	09		05			57, 11				
8"	2"	2-3/16"	1000	1-3/16"						SU80JL84
		2-7/16"		1/2"	92	9S	60, 63 [~]	6S, 72 [~]	56, 12	SU80JL**
				3/4"	09	05			57, 11	

90 & 92
Include
Spanner

[~] Include top
hats.



POLYON MAXROK™

- Polyurethane chemically bonded on glass filled nylon core
- Quiet operation with high impact resistance
- Temperature range: -45° F to 180° F
- Color options: Green and Red
- Durometer: Shore A 95(+/-5)

MU WHEELS • CAPACITY 1400



Wheel Diameter	Tread Width	Hub Length	Load Capacity	Bore I.D.	Color Code	Replace ** with desired bearing code						Part Number
						Roller Brg.	Stainless Roller Brg.	Annular Ball Brg.	Prec. Ball Brg.	Stainless Prec. Ball Brg.	Delrin Brg.	
4"	2"	2-3/16"	700	1-3/16"	Green=G Red=K							MU40J+84
		2-7/16"		1/2"		92	9S	48		56, 12	MU40J+**	
				5/8"		02		60	6S			
				3/4"		04, 09	05			57, 11		
5"	2"	2-3/16"	1000	1-3/16"	Green=G Red=K							MU50J+84
		2-7/16"		1/2"		92	9S	48		56, 12	MU50J+**	
				5/8"		02		60	6S			
				3/4"		04, 09	05			57, 11		
6"	2"	2-3/16"	1200	1-3/16"	Green=G Red=K							MU60J+84
		2-7/16"		1/2"		92	9S	48		56, 12	MU60J+**	
				5/8"		02		60	6S			
				3/4"		04, 09	05			57, 11		
8"	2"	2-3/16"	1400	1-3/16"	Green=G Red=K							MU80J+84
		2-7/16"		1/2"		92	9S	48		56, 12	MU80J+**	
				5/8"		02		60	6S			
				3/4"		04, 09	05			57, 11		

92 & 9S include spanner



POLYON AL™

- Polyurethane chemically bonded on aluminum core
- Quiet in operation with attractive appearance
- Temperature range: -45°F to +180° F
- Durometer: Shore A 95(+/-5)
- Variety of Color options

PA WHEELS • CAPACITY 1500



Wheel Dia.	Tread Width	Hub Length	Load Cap.	Bore I.D.	Color Code(+)	Replace ** with desired bearings code						Part Number Replace + with Color Code
						Annular Brg.	Prec. Ball Brg.	Stainless Ball Brg.	Roller Brg.	Stainless Roller Brg.	Delrin Brg.	
3"	1-1/4"	1-19/32"	380	3/8"	Blue	43						PA30GL43
3.5"	1-1/4"	1-19/32"	400	3/8"	Blue	43						PA35GL43
					Maroon							PA35GM43
4"	1-1/4"	1-19/32"	420	3/8"	Blue	43						PA40GL43
5"	1-1/4"	1-19/32"	440	3/8"	Blue	43						PA50GL43
	1-3/8"	1-19/32"	500	1/2"	Red	43						PA50VV60
4"	1-1/2"	1-5/8"	700	1-3/16"	B=Black N=Green R=Red							PA40H+84
		1-7/8"		1/2"			6M		56, 12	PA40H+**		
				5/8"				01	57, 11			
				3/4"				03				
4"	2"	2-3/16"	800	1-3/16"	N=Green R=Red M=Maroon							PA40J+84
				1/2"		48	60	6S	92	9S	56, 12	PA40J+**
				5/8"					02			
				3/4"					04, 09	05	57, 11	
5"	1-1/2"	1-5/8"	800	1-3/16"	N=Green R=Red							PA50H+**
				1/2"			6M			56, 12		
				5/8"					01		57, 11	
				3/4"					03			
5"	2"	2-3/16"	900	1-3/16"	N=Green R=Red M=Maroon							PA50J+84
				1/2"		48	60	6S	92	9S	56, 12	PA50J+**
				5/8"					02			
				3/4"					04, 09	05	57, 11	
6"	1-1/2"	1-5/8"	800	1-3/16"	N=Green R=Red							PA60H+**
				1/2"			6M			56, 12		
				5/8"					01		57, 11	
				3/4"					03			
6"	2"	2-3/16"	1200	1-3/16"	N=Green R=Red M=Maroon C=Black							PA60J+84
				1/2"		48	60	6S	92	9S	56, 12	PA60J+**
				5/8"					02			
				3/4"					04, 09	05	57, 11	
8"	2"	2-3/16"	1500	1-3/16"	N=Green R=Red M=Maroon							PA80J+84
				1/2"		48	60	6S	92	9S	56, 12	PA80J+**
				5/8"					02			
				3/4"					04, 09	05	57, 11	

92 & 9S include spanner



ENERGY SAVER POLYON™

- Polyurethane tread specially engineered with high tencile and for low initial force to push/pull.
- Crowned polyurethane tread chemically bonded to a solid heavy-duty cast iron core
- Variety of bearing options for optimal performance at different applications
- Temperature range -40°F to +180° F
- Color: Dark blue tread on black core
- Durometer: Shore A 95 (+/-5)

SW WHEELS • CAPACITY 4200

SW80JU63

SW60JU04

SW60LU85



Wheel Diameter	Tread Width	Hub Length	Load Capacity	Bore I.D.	Replace ** with desired bearing code			Part Number
					Roller Brg.	Prec. Ball Brg.	Prec. Tapered Brg.	
4"	1-1/2"	1-5/8"	600	1-3/16"	01,03			SW40HU**
		1-7/8"		1/2"	92	6M		
				5/8"	01			
				3/4"	03			
4"	2"	2-3/16"	800	1-3/16"				SW40JU84
		2-7/16"		1/2"	92	60		SW40JU**
				5/8"	02			
				3/4"	04,09			
5"	1-1/2"	1-5/8"	800	1-3/16"				SW50HU84
		1-7/8"		1/2"	92	6M		SW50HU**
				5/8"	01			
				3/4"	03			
5"	2"	2-3/16"	1300	1-3/16"				SW50JU84
		2-7/16"		1/2"	92	60		SW50JU**
				5/8"	02			
				3/4"	04,09			
6"	1-1/2"	1-5/8"	850	1-3/16"				SW60HU84
		1-7/8"		1/2"	92	6M		SW60HU**
		1-7/8"		5/8"	01			
		1-7/8"		3/4"	03			
6"	2"	2-3/16"	1400	1-3/16"				SW60JU84
		2-7/16"		1/2"	92	60	73	SW60JU**
				5/8"	02			
				3/4"	04,09		70	
6"	2-1/2"	2-3/4"	1700	1-15/16"				SW60KU85
		3"		3/4"	93	89	70	SW60KU**
				1"	23			
				1-1/4"	25			
6"	2-1/2"	3-1/4"	1700	1-15/16"				SW60QU85
		3-1/2"		3/4"	93	69	70	SW60QU**
				1"	24	R1		
				1-1/4"	26			
6"	3"	3-1/4"	2200	1-15/16"				SW60LU85
		3-1/2"		3/4"	93	65*, 69	70	SW60LU**
				1"	24	R1		
				1-1/4"	26			

#92 & 93 include spanner

*Including Top Hats



Wheel Diameter	Tread Width	Hub Length	Load Capacity	Bore I.D.	Replace ** with desired bearing code			Part Number
					Roller Brg.	Prec. Ball Brg.	Prec. Tapered Brg.	
8"	2"	2-3/16"	1500	1-3/16"				SW80JU84
		2-7/16"		1/2"	92	60, 63 [~]	73	SW80JU**
				5/8"	02			
				3/4"	04,09		70	
8"	2-1/2"	2-3/4"	2200	1-15/16"				SW80KU85
		3"		3/4"	93	89	70	SW80KU**
				1"	23			
				1-1/4"	25			
8"	2-1/2"	3-1/4"	2200	1-15/16"				SW80QU85
				3/4"	93	69	70	SW80QU**
				1"	24	R1		
				1-1/4"	26			
8"	3"	3-1/4"	2700	1-15/16"				SW80LU85
		3-1/2"		3/4"	93	65 [~] , 69	70	SW80LU**
				1"	24	R1	71	
				1-1/4"	26			
10"	2-1/2"	2-3/4"	2400	1-15/16"				SW10KU85
		3"		3/4"	93	89	70	SW10KU**
				1"	23			
				1-1/4"	25			
10"	2-1/2"	3-1/4"	2400	1-15/16"				SW10QU85
		3-1/2"		3/4"	93	69		SW10QU**
				1"	24	R1		
				1-1/4"	26			
10"	3"	3-1/4"	3000	1-15/16"				SW10LU85
		3-1/2"		3/4"	93	69	70	SW10LU**
				1"	24	R1	71	
				1-1/4"	26			
12"	2-1/2"	2-3/4"	2700	1-15/16"				SW12KU85
		3"		3/4"	93	89		SW12KU**
				1"	23			
				1-1/4"	25			
12"	2-1/2"	3-1/4"	2700	1-15/16"				SW12QU85
		3-1/2"		3/4"	93	69		SW12QU**
				1"	24	R1		
				1-1/4"	26			
12"	3"	3-1/4"	4200	1-15/16"				SW12LU85
		3-1/2"		3/4"	93	69	70	SW12LU**
				1"	24	R1	71	
				1-1/4"	26			

#92 & 93 include
spanner

[~]Including Top Hats



POLY-PRO™

- Non-Marking polyurethane tread mechanically locked to Polyolefin core
- Variety of designs, colors and bearing options available
- Temperature range: -20° F to +180° F
- Durometer: Shore A 95

PP WHEELS • CAPACITY 1400

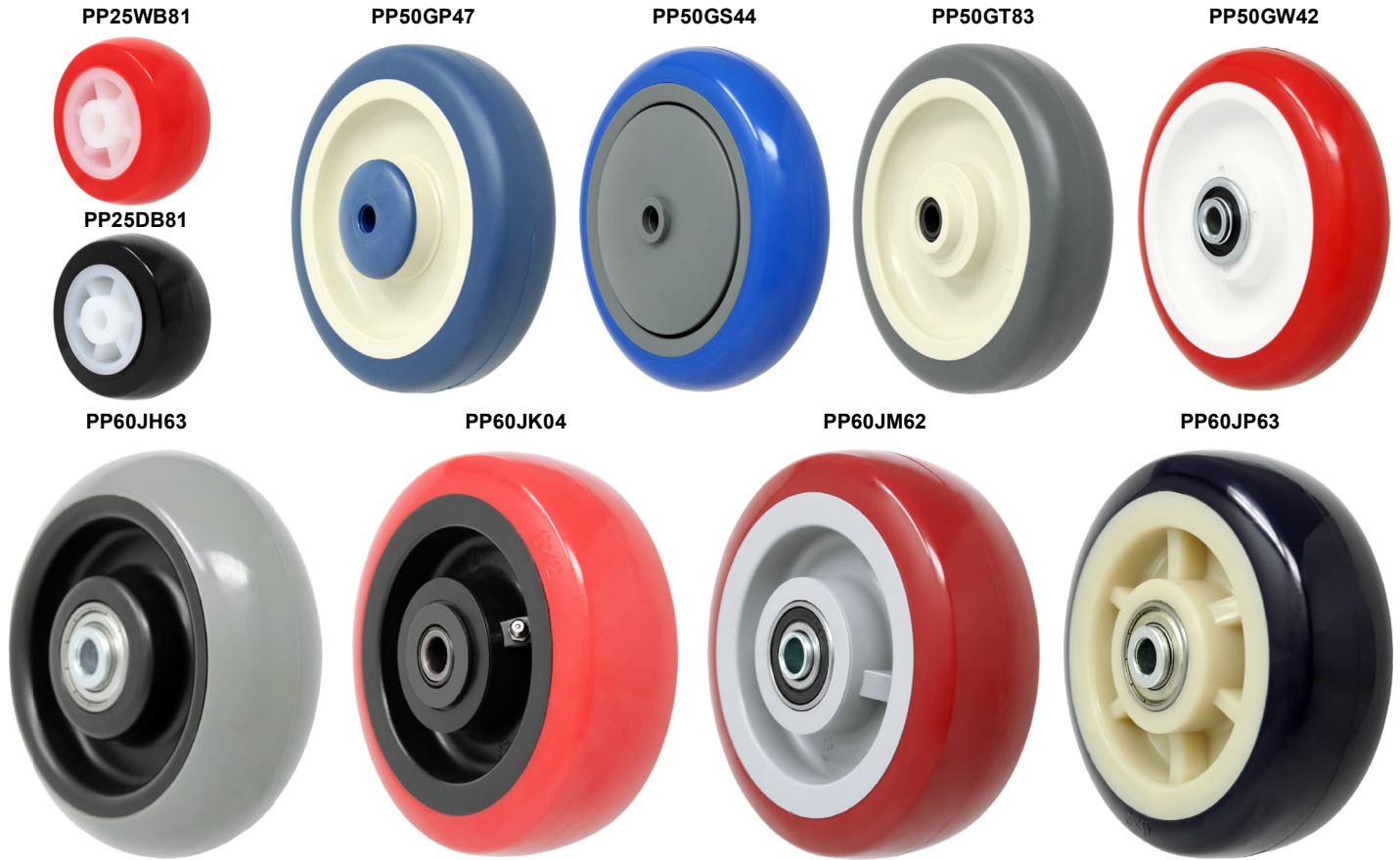

Wheel Diameter	Tread Width	Hub Length	Load Capacity	Bore I.D.	Available Color tread/core(+)	Replace ** with desired bearing code						Part Number Replace + with Color Code	
						Dual Ball Brg.	S.S Dual Ball Brg.	Single Pre. Ball Brg.	S.S. Single Pre. Ball Brg.	Dual Prec. Ball Brg.	Delrin Brg./ Sleeve		
2"	7/8"	15/16"	75	1/4"	T							PP20BT80	
2"	13/32"	1-1/32"	100	1/4"	Blue	P0						PP20ASP0	
2"	7/8"	1"	90	1/4"	Red							PP20DW80	
					Black							PP20DB80	
2.5"	1-1/8"	1-3/8"	100	5/16"	Red							PP25DW81	
					Black							PP25D+81	
2.5"	1-3/8"	1-5/8"	250	1-1/8"	M, W							PP25G+98	
				3/8"	M, W, I	42				55,59	PP25G+**		
3"	13/16"	1"	80	1/4"	Gray/Beige							PP30AT80	
3"	13/16"	1"	150	1/4"	Blue/Gray			P0				PP30ASP0	
3"	1"	1-1/8"	125	5/16"	T, H							PP30D+81	
					Gray/Gray			41				PP30DI41	
3"	1-1/4"	1-5/8"	300	1-1/8"	K, W							PP30G+98	
				3/8"		42	2S			55	PP30G+**		
				1/2"						59	PP30G+59		
3"	1-1/4"	1-5/8"	300	3/8"	A, D, I, K, S			44				PP30G+44	
3"	1-1/4"	1-5/8"	300	3/8"	Gray/Beige(flat)			47				PP30GT47	
3"	1-1/4"	1-5/8"	300	3/8"	Gray/Beige(donut)							PP30GY47	
3"	1-1/4"	1-5/8"	300	1/2"	Gray/Beige(flat)							PP30GT83	
3"	1-1/4"	1-5/8"	300	1/2"	Gray/Beige(donut)							PP30GT83	
3.5"	1-1/4"	1-5/8"	300	1-1/8"	K,W,P								PP35G+98
				3/8"		42	2S			55	PP35G+**		
				1/2"						59	PP30G+59		
3.5"	1-1/4"	1-5/8"	300	3/8"	A,D,I,K,S			44				PP30G+44	
3.5"	1-1/4"	1-5/8"	300	3/8"	Gray/Beige(flat)			47				PP35GT47	
3.5"	1-1/4"	1-5/8"	300	3/8"	Gray/Beige(donut)							PP35GY47	
3.5"	1-1/4"	1-5/8"	300	1/2"	Gray/Beige(flat)							PP30GT83	
3.5"	1-1/4"	1-5/8"	300	1/2"	Gray/Beige(donut)							PP30GY83	



PP WHEELS • CAPACITY 1400

Wheel Diameter	Tread Width	Hub Length	Load Capacity	Bore I.D.	Available Color tread/core(+)	Replace ** with desired bearing code						Part Number Replace + with Color Code
						Dual Ball Brg.	S.S Dual Ball Brg.	Single Pre. Ball Brg.	S.S. Single Pre. Ball Brg.	Dual Prec. Ball Brg.	Delrin Brg./ Sleeve	
4"	1"	1-1/8"	140	5/16"	T, H							PP40D+81
4"	1-1/4"	1-5/8"	350	1-1/8"	W,K,P							PP40G+98
				3/8"		42	2S			55	PP40G+55	
				1/2"						59	PP40G+59	
4"	1-1/4"	1-5/8"	350	3/8"	P				4S			PP40GP4S
4"	1-1/4"	1-5/8"	350	3/8"	A,D,I,S,C			44				PP40G+44
4"	1-1/4"	1-5/8"	350	3/8"	Gray/Beige(flat)			47				PP40GT47
					Blue/Beige(flat)							PP40GP47
4"	1-1/4"	1-5/8"	350	3/8"	Gray/Beige(donut)			47				PP40GY47
4"	1-1/4"	1-5/8"	350	3/8"	Gray/Beige(flat)							PP40GT83
4"	1-1/4"	1-5/8"	350	3/8"	Gray/Beige(donut)							PP40GY83
4"	1-1/2"	1-5/8"	350	3/8"	Black/Gray	42						PP40HA42
5"	1"	1-1/8"	140	5/16"	T, H							PP50D+81
5"	1-1/4"	1-5/8"	350	1-1/8"	I, K, P, W							PP50G+98
				3/8"		42	2S			55	PP50G+55	
				1/2"						59	PP50G+59	
5"	1-1/4"	1-5/8"	350	5/16"	P	50						PP50GP50
5"	1-1/4"	1-5/8"	350	3/8"	P				4S			PP50GP4S
5"	1-1/4"	1-5/8"	350	3/8"	A,D,I,S,C			44				PP50G+44
5"	1-1/4"	1-5/8"	350	3/8"	Gray/Beige(flat)			47				PP50GT47
					Blue/Beige(flat)							PP50GP47
5"	1-1/4"	1-5/8"	350	3/8"	Gray/Beige(donut)			47				PP50GY47
5"	1-1/4"	1-5/8"	350	3/8"	Gray/Beige(flat)							PP50GT83
5"	1-1/4"	1-5/8"	350	3/8"	Black/Black							PP50GB83
5"	1-1/4"	1-5/8"	350	3/8"	Gray/Beige(donut)							PP50GY83
6"	1-1/4"	1-5/8"	350	1-1/8"	A, I, W							PP60G+98
				3/8"		42	2S			55	PP60G+55	
				1/2"						59	PP60G+59	
6"	1-1/4"	1-5/8"	350	3/8"	A, I				44			PP60G+44
6"	1-1/4"	1-5/8"	350	3/8"	Gray/Beige(flat)				47			PP60GT47
6"	1-1/4"	1-9/16"	350	1/2"	Gray/Beige(flat)							PP60GT83



Wheel Diameter	Tread Width	Hub Length	Load Capacity	Bore I.D.	Available Color tread/core(+)	Replace ** with desired bearing code						Part Number Replace + with Color Code
						Ball Brg.	Roller Brg.	Stainless Roller Brg.	Prec. Ball Brg.	S.S Prec. Ball Brg.	Delrin Brg./ Sleeve	
3"	1-3/4"	2"	450	1/2"	Maroon/Gray				62			PP30IM62
4"	1-1/2"	1-7/8"	400	1-3/16"	K,U		01,03					PP40H+84
				1/2"			6M		56, 12			
				5/8"			01				PP40H+**	
				3/4"			03			57, 11		
4"	2"	2-7/16"	500	1-3/16"	K, M, U, W	48	92	9S	60	6S	56, 12	PP40J+84
				1/2"			02				PP40J+**	
				5/8"			04, 09	05		57, 11		
				3/4"								
4"	2"	2-7/16"	500	1/2"	Maroon/Gray				62		PP40JM62	
4"	2"	2-7/16"	500	1/2"	Blue/Gray				62	72~	PP40JP63	
5"	1-1/2"	1-7/8"	450	1-3/16"	K, S, T, U							PP50H+84
				1/2"			6M		56, 12			
				5/8"			01				PP50H+**	
				3/4"			03			57, 11		
5"	2"	2-7/16"	600	1-3/16"	B,C,K,U,M,W	48	92	9S	60, 62	6S		PP50J+84
				1/2"			02				PP50J+**	
				5/8"			04, 09	05				
				3/4"								
5"	2"	2-7/16"	750	1-3/16"	Gray-donut tread	48	92	9S	60	6S	56, 12	PP50JH84
				1/2"			02				PP50JH**	
				5/8"			04, 09	05		57, 11		
				3/4"								
5"	2"	2-7/16"	750	1/2"	Gray-donut tread				63~	72~	PP50JH**	
5"	2"	2-7/16"	600	1/2"	Maroon/Gray				62~	72~	PP50JM**	
5"	2"	2-7/16"	750	1/2"	Purple/Cream				63~	72~	PP50JP63	
6"	1-1/2"	1-7/8"	600	1-3/16"	K, M, T, U							PP60H+84
				1/2"			92			56, 12		
				5/8"			01				PP60HT95	
				3/4"			03			57, 11		
6"	2"	2-7/16"	720	1-3/16"	I,K,M,W,U	48	92	9S	60	6S	56, 12	PP60J+84
				1/2"			02				PP60J+**	
				5/8"			04, 09	05		57, 11		
				3/4"								
6"	2"	2-7/16"	800	1/2"	Gray-donut tread				63~	72~	PP60JH**	
6"	2"	2-7/16"	720	1/2"	Maroon/Gray				62	72~	PP60JM**	
6"	2"	2-7/16"	800	1/2"	Purple/Cream				62	72~	PP60JP**	
6"	2"	2-7/16"	720	1/2"	Blue/black				62		PP60JU62	
8"	1-1/2"	2-1/4"	600	1-3/8"	T,I							PP80H+95
				1/2"		51, P1					PP80H+**	
				5/8"		52, P2						
				3/4"		53, P3						
8"	2"	2-7/16"	800	1-3/16"	C,D,I,K,M,U,W	48	92	9S	60	6S	56, 12	PP80J+84
				1/2"			02				PP80J+**	
				5/8"			04, 09	05		57, 11		
				3/4"								
8"	2"	2-7/16"	1000	1/2"	Gray-donut tread				63~	72~	PP80JH**	
8"	2"	2-7/16"	800	1/2"	Red/Black				62		PP80JK62	
8"	2"	2-7/16"	800	1/2"	Maroon/Gray				62		PP80JM62	
8"	2"	2-7/16"	1000	1/2"	Purple/Cream				62	72~	PP80JP**	
8"	2-1/2"	3"	1100	1-15/16"	Maroon/Gray						58	PP80KM85
				3/4"			93				89	
				1"			23				58	PP80KM**
				1-1/4"			25					
8"	3"	3-1/2"	1150	1-15/16"	Maroon/Gray							PP80LM85
				3/4"			93		69			
				1"			24		R1		58	PP80LM**
				1-1/4"			26					
10"	1-1/2"	2-1/4"	700	1-3/8"	T,I							PP10H+95
				1/2"		51, P1						PP10H+**
				5/8"		52, P2						
				3/4"		53, P3						
10"	2-1/2"	3"	1200	1-15/16"	Maroon/Gray							PP10KM85
				3/4"			93		89			
				1"			23			58	PP10KM**	
				1-1/4"			25					
10"	3"	3-1/2"	1250	1-15/16"	Maroon/Gray							PP10LM85
				3/4"			93		69			
				1"			24		R1		58	PP10LM**
				1-1/4"			26					
12"	2-1/2"	3"	1400	1-15/16"	Maroon/Gray							PP12KM85
				3/4"			93		89			
				1"			23			58	PP12KM**	
				1-1/4"			25					
12"	3"	3-1/2"	1400	1-15/16"	Maroon/Gray							PP12LM85
				3/4"			93		69			
				1"			24		R1		58	PP12LM**
				1-1/4"			26					

~including Top Hats



POLYON™

- Precision ball bearings and tapered roller bearings are available
- Polyurethane tread chemically bonded to cast iron core
- Temperature range: -40°F to +180°F
- Durometer Shore A 95 (+/-5)

PU50GB83



PU80JG04



PU80JV63



PU WHEELS • CAPACITY 4400

Wheel Diameter	Tread Width	Hub Length	Load Capacity	Bore I.D.	Available Color tread/core(+)	Replace ** with desired bearing code			Part Number Replace + with Color Code
						Roller Bearing	Precision Ball Bearing	Delrin Bearings	
3"	1-1/4"	1-1/2"	800	1-3/16"	Red/Silver				PU30GV84
		1-3/4"		1/2"		92			PU30GV92
		1-11/16"		3/4"		S3			PU30GVS3
3-1/4"	1-1/2"	1-5/8"	500	1-3/16"	Green/Black				PU34HG84
		1-7/16"		1/2"		92	6M	56, 12	PU34HG**
				5/8"		01			
				3/4"		03		57, 11	
3-1/2"	2"	2-3/16"	600	1-3/16"	Green/Black				PU34JG84
		2-7/16"		1/2"		92	60	56, 12	PU34JG**
				5/8"		02			
				3/4"		03		57, 11	
4"	1-1/4"	1-1/2"	500	1/2"	Black				PU40GB83
4"	1-1/2"	1-5/8"	670	1-3/16"	G=Green/Black V=Red/Silver				PU40H+84
		1-7/8"		1/2"		92	6M	56, 12	PU40H+**
				5/8"		01			
				3/4"		03		57, 11	
4"	2"	2-3/16"	800	1-3/16"	G=Green/Black V=Red/Silver				PU40J+84
		2-7/16"		1/2"		92		56, 12	PU40J+**
				5/8"		02			
				3/4"		04, 09		57, 11	
4"	2"	2-7/16"	800	1/2"	Red/Silver		63		PU40JV63



Wheel Diameter	Tread Width	Hub Length	Load Capacity	Bore I.D.	Available Color tread/core(+)	Replace ** with desired bearing code			Part Number Replace + with Color Code
						Roller Bearing	Precision Ball Bearing	Delrin Bearings	
5"	1-1/4"	1-1/2"	700	1/2"	Black				PU50GB83
5"	2"	1-5/8"	1100	1-3/16"	G=Green/Black V=Red/Silver				PU50H+84
		1-7/8"		1/2"		92	6M	56, 12	PU50J+**
				5/8"		01			
				3/4"		03		57, 11	
5"	2-1/2"	2-3/4"	1400	1-15/16"	Green/Black				PU50KG85
		3"		3/4"		93	89		PU50KG**
				1"		23		58	
				1-1/4"		25			
5"	3"	3-1/4"	1600	1-15/16"	G=Green/Black V=Red/Silver				PU50L+85
		3-1/2"		3/4"		93	69		PU50L+**
				1"		24		58	
				1-1/4"		26			
6"	1-1/2"	1-5/8"	800	1-3/16"	G=Green/Black V=Red/Silver				PU60H+84
		1-7/8"		1/2"		92	6M	56, 12	PU60H+**
				5/8"		01			
				3/4"		03		57, 11	
6"	2"	2-3/16"	1200	1-3/16"	G=Green/Black V=Red/Silver				PU60J+84
		2-7/16"		1/2"		92		56, 12	PU60J+**
				5/8"		02			
				3/4"		04, 09		57, 11	
6"	2"	2-7/16"	1200	1/2"	Red/Silver		63		PU60JV63
6"	2"	2-1/4"	1200	1-7/16"	Red/Silver				PU60JV87
				3/4"		07			PU60JV07
				1"		22			PU60JV22
6"	2-1/2"	2-3/4"	1500	1-3/16"	Red/Silver				PU60KV84
		3"		1/2"		92		56	PU60KV**
				3/4"		06		57	
6"	2-1/2"	2-3/4"	1600	1-15/16"	G=Green/Black V=Red/Silver				PU60K+85
		3"		3/4"		93	89		PU60K+**
				1"		23		58	
				1-1/4"		25			
6"	2-1/2"	3-1/4"	1600	1-15/16"	G=Green/Black V=Red/Silver				PU60Q+85
		3-1/2"		3/4"		93	69		PU60Q+**
				1"		24	R1	58	
				1-1/4"		26			
6"	3"	3-1/4"	2000	1-15/16"	G=Green/Black V=Red/Silver				PU60L+85
		3-1/2"		3/4"		93	69		PU60LG**
				1"		24	R1	58	
				1-1/4"		26			
6"	3"	3-1/2"	2000	3/4"	Green/Black		65		PU60LG65



PU WHEELS • CAPACITY 4400

Wheel Diameter	Tread Width	Hub Length	Load Capacity	Bore I.D.	Available Color tread/core(+)	Replace ** with desired bearing code			Part Number Replace + with Color Code	
						Roller Bearing	Precision Ball Bearing	Delrin Bearings		
8"	2"	2-3/16"	1400	1-3/16"	G=Green/Black V-Red/Silver				PU80J+84	
		2-7/16"		1/2"		92	60	56, 12	PU80J+**	
				5/8"		02				
				3/4"		04, 09		57, 11		
8"	2"	2-7/16"	1400	1/2"	Red/Silver		63		PU80JV63	
8"	2"	2-1/4"	1400	1-7/16"	Red/Silver				PU60JV87	
				3/4"		07			PU60JV07	
				1"		22			PU60JV22	
8"	2-1/2"	2-3/4"	1600	1-3/16"	Red/Silver				PU80KV84	
		3"		1/2"		92		56	PU80KV**	
				3/4"		06		57		
8"	2-1/2"	3"	2000	1-15/16"	G=Green/Black V-Red/Silver				PU80K+85	
				3/4"		93	89		PU80K+**	
				1"		23		58		
				1-1/4"		25				
8"	2-1/2"	3-1/4"	2000	1-15/16"	G=Green/Black V-Red/Silver				PU80Q+85	
		3-1/2"		3/4"		93	69		PU80Q+**	
				1"		24	R1	58		
				1-1/4"		26				
8"	3"	3-1/4"	2500	1-15/16"	G=Green/Black V-Red/Silver				PU80L+85	
		3-1/2"		3/4"		93	69		PU80LG**	
				1"		24	R1	58		
8"	3"	3-1/2"	2500	1-1/4"		26				
8"	3"	3-1/2"	2500	3/4"	Green/Black		65		PU80LG65	
8"	3"	3-1/2"	2500	3/4"	Red/Silver		65		PU80LV85	
10"	2-1/2"	2-3/4"	1600	1-3/16"	Red/Silver				PU10KV84	
		3"		1/2"		92		56	PU10KV**	
				3/4"		06		57		
10"	2-1/2"	3"	2200	1-15/16"	G=Green/Black V-Red/Silver				PU10K+85	
				3/4"				89		PU10K+**
				1"		23		58		
				1-1/4"		25				
10"	2-1/2"	3-1/4"	2200	1-15/16"	G=Green/Black V-Red/Silver				PU10Q+85	
		3-1/2"		3/4"			69		PU10Q+**	
				1"		24	R1	58		
				1-1/4"		26				
10"	3"	3-1/4"	3000	1-15/16"	G=Green/Black V-Red/Silver				PU10L+85	
		3-1/2"		3/4"			69		PU10L+**	
				1"		24	R1	58		
				1-1/4"		26				
10"	3"	3-1/2"	3000	3/4"	Green/Black		65		PU10LG65	
10"	4"	4-1/4"	3200	1-15/16"	Red/Silver				PU10NV85	
		4-1/2"		1"		35			PU10NV35	
12"	2-1/2"	2-3/4"	2500	1-15/16"	G=Green/Black V-Red/Silver				PU12K+85	
		3"		3/4"		93	89		PU12K+**	
				1"		23		58		
				1-1/4"		25				
12"	2-1/2"	3-1/4"	2500	1-15/16"	G=Green/Black V-Red/Silver				PU12Q+85	
		3-1/2"		3/4"		93	69		PU12Q+**	
				1"		24	R1	58		
				1-1/4"		26				
12"	3"	3-1/4"	3500	1-15/16"	G=Green/Black V-Red/Silver				PU12L+85	
		3-1/2"		3/4"		93	69		PU12L+**	
				1"		24	R1	58		
				1-1/4"		26				
12"	3"	3-1/2"	3500	3/4"	Green/Black		65		PU12LG65	
16"	3"	3-1/4"	4400	1-15/16"	Green/Black				PU16LG85	
		3-1/2"		3/4"		92	69		PU1+A18:J1326LG**	
				1"		24	R1	58		
				1-1/4"		26				

#92 & 93 Including Spanner
 ~Including Top hats



Welded Disc Polyurethane Wheels - Nickel Plated or Stainless Steel

- Attractive appearance while supporting greater load capacity and floor protection
- Polyurethane tire molded to fit permanently between two discs.
- Ball Bearings with precisely machined bearings raceway
- Temperature Range: -40°F to +180°F
- Standard color Blue tread
- Tread Hardness 95(+/-5)

US/UN,ET WHEELS • CAPACITY 4400

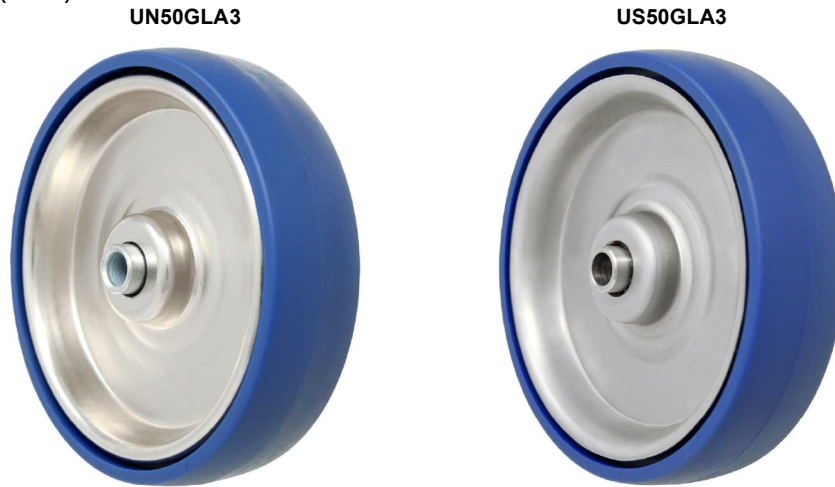

Wheel Diameter	Wheel Width	Hub Length	Load Capacity	Bore I.D.	Part #
3-1/2"	1-1/4"	1-5/8"	250	3/8"	UN35GLA3
4"			270		UN40GLA3
5"			300		UN50GLA3
Welded Disc Polyurethane Wheels - Stainless Disc. Hub					
Wheel Diameter	Wheel Width	Hub Length	Load Capacity	Bore I.D.	Part #
4"	1-1/4"	1-5/8"	270	3/8"	US40GLA3
5"			300		US50GLA3

ELITE WHEEL

- Solid Polyolefin core, mechanically and fully covered with Polyurethane
- Wheels with dual ball bearings
- Quiet with higher load rating
- Durometer Shore D 65



Wheel Diameter	Tread Width	Hub Length	Load Capacity	Bore I.D.	Part Number
3"	1-1/4"	1-9/16"	450	3/8"	ET30GL42
4	1-1/4"	1-9/16"	475	3/8"	ET40GL42
5	1-1/4"	1-9/16"	475	3/8"	ET50GL42



Crystal Polyurethane

- Unique appearance with excellent shock absorption
- Wheels with dual precision bearings
- Hardness Shore A 80 - 85



Wheel Diameter	Tread Width	Hub Length	Load Capacity	Bore I.D.	Fit on Caster Series	Part Number Replace + with Color Code
2"	13/16"	13/16"	80	5/16"	FH	CL0502288CG
3"	7/8"	1-11/64"	120	5/16"	8A,09, FH	CL0762488CG
4"	7/8"	1-31/32"	140	5/16"	8A,09	CL1002488CG

Ergo-Elastomer™

- Non-Marking and high-performance polyurethane tread mechanically casted to polyolefin core
- Dual precision bearings enhance its performance.
- Durometer Shore A 80 - 85
- Bright Orange tread
- NSF Listed



Wheel Diameter	Tread Width	Hub Length	Load Capacity	Bore I.D.	Part Number Replace + with Color Code
3"	1-1/4"	1-5/8"	300	3/8"	EU30GOD0
4"	1-1/4"	1-5/8"	350	3/8"	EU40GOD0
5"	1-1/4"	1-5/8"	375	3/8"	EU50GOD0

CL, EU WHEELS • CAPACITY 375



POLYMADIC™

- High performance UV resistant polyurethane mechanically locked to polyolefin core
- 1-1/4" wide wheels are maroon tread on gray core, w/dual row annular ball bearings
- Temperature range -20° F to +180° F
- Durometer: Shore D 60 (+/- 5)

PM80JM92



PM WHEELS • CAPACITY 1000

Wheel Diameter	Tread Width	Hub Length	Load Capacity	Bore I.D.	Available Color	Replace ** with desired bearing code						Part Number Replace + with Color Code
						Dual Row Annular BB	Roller Bearings	S.S. Roller Bearings	Precision Bearings	S.S.Precision Bearings	Delrin Bearings	
3"	1-13/16"	2"	350	1/2"	Maroon/Gray				62			PM30IM62
	1-1/4"	1-9/16"	300	3/8"		43						PM30GM43
				1/2"						5A	PM30GM5A	
3-1/2"	1-1/4"	1-9/16"	270	3/8"	Maroon/Gray	43						PM35GM43
				1/2"						5A	PM35GM5A	
4"	1-1/4"	1-9/16"	350	3/8"	Maroon/Gray	43						PM40GM43
				1/2"						5A	PM40GM5A	
5"	1-1/4"	1-9/16"	350	3/8"	Maroon/Gray	43						PM50GM43
				1/2"						5A	PM50GM5A	
4"	2"	2-3/16"	600	1-3/16"	I=Gray/Gray M=Maroon/ Gray							PM40J+84
		1/2"		48		92	9S	60, 62	6S	56, 12	PM40J+**	
		5/8"				02						
		3/4"				04, 09	05			57, 11		
5"	2"	2-3/16"	750	1-3/16"	I=Gray/Gray M=Maroon/ Gray	48						PM50J+84
		1/2"				92	9S	60, 62	6S	56, 12	PM50J+**	
		5/8"				02						
		3/4"				04, 09	05			57, 11		
6"	2"	2-3/16"	900	1-3/16"	I=Gray/Gray M=Maroon/ Gray	48						PM60J+84
		1/2"				92	9S	60, 62	6S	56, 12	PM60J+**	
		5/8"				02						
		3/4"				04, 09	05			57, 11		
8"	2"	2-3/16"	1000	1-3/16"	I=Gray/Gray M=Maroon/ Gray	48						PM80J+84
		1/2"				92	9S	60, 62	6S	56, 12	PM80J+**	
		5/8"				02						
		3/4"				04, 09	05			57, 11		



POLYON-C

- Slight crowned tread mechanically bonded to an aluminum center
- Temperature range: -40°F to +180°F
- Durometer: Shore A 95
- Quiet in operation
- Color: Blue

PR WHEELS • CAPACITY 1200

PR60JL04

PR50JL04



Wheel Diameter	Tread Width	Hub Length	Load Capacity	Bore I.D.	Available Color	Replace ** with desired bearing code						Part Number Replace + with Color Code
						Dual Row Annular BB	Roller Bearings	S.S. Roller Bearings	Precision Bearings	S.S.Precision Bearings	Delrin Bearings	
5"	2"	2-3/16"	900	1-3/16"								PR50JL84
		2-7/16"		1/2"		48	92	9S	60	6S	56, 12	PR50JL**
				5/8"			02					
				3/4"			04, 09	05				
6"	2"	2-3/16"	1200	1-3/16"								PR60JL84
		2-7/16"		1/2"		48	92	9S	60	6S	56, 12	PR60JL**
				5/8"			02					
				3/4"			04, 09	05				

NOTES

NEO-ENERGIZER WHEEL

- Highly resistant to wax, oil, grease, cleaning compounds, weather and ozone
- Will reject debris, roll over screws, metal or glass fragments and resin pellets
- Temperature range 300° F for 20 minutes, 175° F for one hour
- Non-Marking, Excellent for all floor surfaces
- Excellent mobility and wear resistance
- Durometer Shore A 61 (+/- 2)
- Neoprene Rubber Tread

EN WHEELS • CAPACITY 1400



Wheel Diameter	Tread Width	Hub Length	Load Capacity	Bore I.D.	Replace ** with desired bearing code						Part Number
					Roller Bearings	Stainless Roller BRG	Sealed Ball BRG	Sealed Pre. Ball BRG	Stainless Sealed Ball BRG	Bronze BRG	
2-1/2"	1-3/8"	1-1/4"	175	1-1/8"							EN25VB98
		1-41/64"		3/8"		2P		2S		EN25VB**	
3"	1-3/8"	1-1/4"	225	1-1/8"							EN30VB98
		1-41/64"		3/8"		2P		2S		EN30VG**	
5"	1-3/8"	1-1/4"	275	1-1/8"							EN50VB98
		1-41/64"		3/8"		2P		2S		EN50VG**	
4"	2"	2-3/16"	500	1-3/16"							EN40JB84
		2-7/16"		1/2"	92		60		6S		EN40JB**
				5/8"	02						
				3/4"	04, 09	05			B1, B7		
5"	2"	2-3/16"	550	1-3/16"							EN50JB84
		2-7/16"		1/2"	92		60		6S		EN50JB**
				5/8"	02						
				3/4"	04, 09	05			B1, B7		
6"	2"	2-3/16"	600	1-3/16"							EN60JB84
		2-7/16"		1/2"	92		60	64"	6S		EN60JB**
				5/8"	02						
				3/4"	04, 09	05			B1, B7		
8	2	2-3/16"	700	1-3/16"							EN80JB84
		2-7/16"		1/2"	92		60	64"	6S		EN80JB**
				5/8"	02						
				3/4"	04, 09	05			B1, B7		
8	2-1/2	3"	1400	3/4"				65"		EN80KB65	

*Includes top hats



Ergo Blue Rubber Wheel

- Made of copolymer rubber with excellent elastic properties
- Superior abrasion resistance, low coefficient of friction
- Non-marking blue

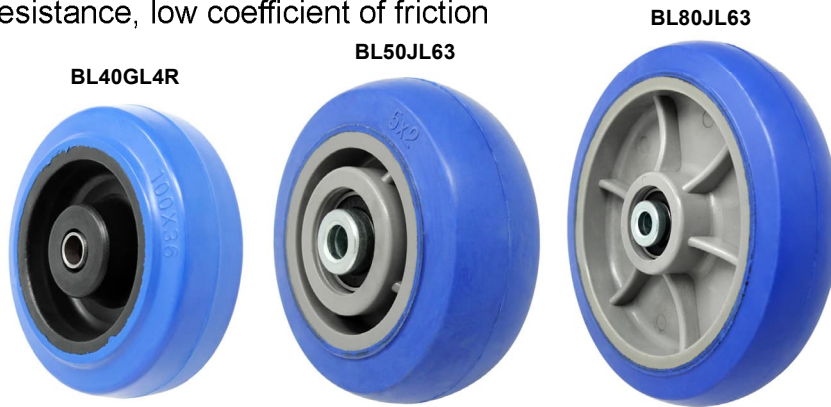

Wheel Diameter	Tread Width	Hub Length	Load Capacity	Bore I.D.	Replace ** with desired bearing code			Part Number
					Precision Ball BRG	Roller Bearing	Stainless Pre. Ball BRG	
4"	1-1/4"	1-9/16"	350	3/8"		4R		BL40GL4R
5"	1-1/4"	1-9/16"	400	3/8"		4R		BL50GL4R
4	2	2-7/16	400	1/2"	63"		72	BL40JL**
5	2	2-7/16	500	1/2"	63"		72	BL50JL**
6	2	2-7/16	600	1/2"	63"		72	BL60JL**
8	2	2-7/16	700	1/2"	63"		72	BL80JL**

**Includes the top hats.

DURA-CUSHION™ WHEEL

- Combining with different options of bearings for minimum surface friction
- High Quality, balloon cushion tread molded on aluminum core
- Temperature range -40°F to 180°F
- Black and gray tread available
- Durometer Shore A 65 (+/- 5)
- Easy rolling over debris



Wheel Diameter	Tread Width	Hub Length	Load Capacity	Bore I.D.	Available Color (+)	Replace ** with desired bearing code				Part Number	
						Precision Ball BRG	Ball BRG	Roller BRG	Delrin BRG		
6"	2"	2-3/16"	650	1-3/16"	X=Gray Z=Black					BC60J+84	
		2-1/8"		1-3/8"						BC60J+95	
		2-1/4"		1/2"		51, P1			BC60J+**		
				5/8"		52, P2					
				3/4"		53, P3					
		2-7/16"		1/2"		63"	92	56, 12			
				5/8"			02				
				3/4"			04, 09	57, 11			
8"	2"		2-3/16"	700	1-3/16"	X=Gray Z=Black					BC80J+84
			2-1/8"		1-3/8"						BC80J+95
		2-1/4"	1/2"		51, P1				BC80J+**		
			5/8"		52, P2						
			3/4"		53, P3						
		2-7/16"	1/2"		63"		92	56, 12			
			5/8"				02				
			3/4"				04, 09	57, 11			

**Includes top hats.

92 includes spanners.



RUBBER ON ALUMINUM WHEEL

- Strong, attractive appearance and lightweight
- Temperature range: -40° F to +160° F
- Gray tread for 1-1/4" wide wheels
- Durometer: Shore A 80(+/- 5)



Wheel Diameter	Tread Width	Hub Length	Load Capacity	Bore I.D.	Tread Color	Replace ** with desired bearings code					Part Number
						Ball BRG	Sealed Ball BRG	Roller BRG	Stainless Roller BRG	Delrin BRG	
3.5"	1-1/4"	1-9/16"	300	3/8"	Gray	43					RA35GI43
4"	1-1/4"	1-9/16"	300	3/8"	Gray	43					RA40GI43
5"	1-1/4"	1-9/16"	325	3/8"	Gray	43					RA50GI43
4"	2"	2-3/16"	400	1-3/16"	Black						RA40JB84
		1/2"				60	92"	56, 12	RA40JB**		
		5/8"					02				
		3/4"				04, 09	05	57, 11			
5"	2"	2-3/16"	500	1-3/16"	B=Black I=Gray						RA50J+84
		1/2"				60	92	56, 12	RA50J+**		
		5/8"					02				
		3/4"				04, 09	05	57, 11			
5"	2"	1-1/2"	500	1-3/8"	Black, Offset						RA50JO95
		1/2"		51		P1			RA50JO**		
		5/8"		52		P2					
		3/4"		53		P3					
6"	2"	2-3/16"	550	1-3/16"	Black						RA60JB84
		1/2"				60	92"	56, 12	RA60JB**		
		5/8"					02				
		3/4"				04, 09	05	57, 11			
6"	2"	1-1/2"	550	1-3/8"	Black, Offset						RA60JO95
		1/2"		51		P1			RA60JO**		
		5/8"		52		P2					
		3/4"		53		P3					
8"	1-1/2"	1-11/16"	500	1-3/8"	Black, Offset						RA80HB95
		1/2"		51		P1			RA80HB**		
		5/8"		52		P2					
		3/4"		53		P3					
8"	1-5/8"	1-13/16"	500	1-3/8"	Black, Centered						RA80PB95
		1/2"		51		P1			RA80PB**		
		5/8"		52		P2					
		3/4"		53		P3					
8"	2"	2-3/16"	600	1-3/16"	B=Black I=Gray						RA80J+84
		1/2"				60	92"	56, 12	RA80J+**		
		5/8"					02				
		3/4"				04, 09	05	57, 11			
10"	2"	2-1/8"	600	1-3/8"	Black						RA10JB95
		1/2"		51		P1			RA10JB**		
		5/8"		52		P2					
		3/4"		53		P3					
10"	2-1/2"	2-7/8"	800	1"	Black		651				RA10KB651
10"	4"	4-1/4"	900	1-15/16"	Black						RA10NB85
				3/4"				92"		RA10NB92	
				1"				35		RA10NB35	
				1-1/4"				37		RA10NB37	
12"	3"	3-1/4"	1000	1-15/16"	Gray					58	RA12LI85
				3/4"			69			RA12LI**	
				1"				24	41		
				1-1/4"				26			

*92 includes the spanner.

RA WHEELS • CAPACITY 900



SURPREME RUBBER

- Variety of bearing options for optimal performance at different applications
- Supreme rubber tread with a tensile strength of 1200 to 1400 PSI
- Extreme heavy duty solid cast iron core
- Best option for power towing applications
- Temperature range: -40°F to +180° F
- Durometer: Shore A 75(+/- 5)

RH WHEELS • CAPACITY 1500



Wheel Diameter	Tread Width	Hub Length	Load Capacity	Bore I.D.	Replace ** with desired bearings code				Part Number
					Sealed Ball BRG	Tapered Roller BRG	Roller BRG	Bronze BRG	
6"	2"	2-3/16"	800	1-3/16"					RH60JS84
		2-7/16"		1/2"	60		92		RH60JS**
				5/8"			02		
				3/4"			04, 09	B1, B7	
8"	2"	2-3/16"	850	1-3/16"					RH80JS84
		2-7/16"		1/2"	60, 63"		92		RH80JS**
				5/8"			02		
				3/4"			04, 09	B1, B7	
8"	3"	3-1/4"	1000	1-15/16"					RH80LS85
		3-1/2"		3/4"	65"	70	93		RH80LS**
				1"			24	78	
				1-1/4"			26		
10"	3"	3-1/4"	1300	1-15/16"					RH80LS85
		3-1/2"		3/4"	69	70	93		RH80LS**
				1"	651	71	24	78	
				1-1/4"			26		
12"	3"	3-1/2"	1400	3/4"		70			RH80LS70
		3-1/2"		1"	651	71			RH80LS**
12"	3-1/2"	4-1/2"	1500	1-1/4"	68"	71			RH12MB**

**includes top hats.

92 & 93 includes spanner.

MOLD-ON RUBBER

- Vulcanized rubber tread on cast iron core
- Temperature range: -40° F to +180° F
- Durometer: Shore A 80 (+/- 5)



Wheel Diameter	Tread Width	Hub Length	Load Capacity	Hub Design Type	Bore I.D.	Replace ** with desired bearings code				Part Number
						Roller BRG	Delrin BRG	Sealed Ball BRG	Bronze BRG	
4"	1-1/2"	1-5/8"	350	C	1-3/16"					RS40HB84
		1-7/8"			1/2"	92	56, 12			RS40HG**
					5/8"	01		6M		
					3/4"	03	57, 11			
4"	2"	2-3/16"	400	C	1-3/16"					RS40JB84
		2-7/16"			1/2"	92	56, 12	60		RS40JB**
					5/8"	02				
					3/4"	04, 09	57, 11		B1, B5	
5"	1-1/2"	1-5/8"	350	C3	1-3/16"					RS50HB84
		1-7/8"			1/2"	92	56, 12	6M		RS50HG**
					5/8"	01				
					3/4"	03	57, 11			
5"	2"	2-3/16"	400	S3	1-3/16"					RS50JB84
		2-7/16"			1/2"	92	56, 12	60		RS50JB**
					5/8"	02				
					3/4"	04, 09	57, 11		B1, B5	
6"	1-1/2"	1-5/8"	350	S3	1-3/16"					RS60HB84
		1-7/8"			1/2"	92	56, 12	6M		RS60HG**
					5/8"	01				
					3/4"	03	57, 11			
6"	2"	2-3/16"	550	S3	1-3/16"					RS60JB84
		2-7/16"			1/2"	92	56, 12	60		RS60JB**
					5/8"	02				
					3/4"	04, 09	57, 11		B1, B5	
6"	2-1/2"	2-3/4"	600	C3	1-3/16"					RS60KB84
		3"			1/2"	92				RS60KB92
					3/4"	06				RS60KB06
6"	2-1/2"	2-3/4"	700	S3	1-15/16"					RS60KB85
		3"			3/4"	93		89		RS60KB**
					1"	23			B7	
					1-1/4"	25				
6"	2-1/2"	3-1/4"	700	C3	1-15/16"					RS60QB85
		3-1/2"			3/4"	93		69		RS60QB**
					1"	24	58	R1	B8	
					1-1/4"	26				
6"	3"	3-1/4"	750	S3	1-15/16"					RS60LB85
		3"			3/4"	93		69		RS60LB**
					1"	24	58	R1	B8	
					1-1/4"	26				



Wheel Diameter	Tread Width	Hub Length	Load Capacity	Hub Design Type	Bore I.D.	Replace ** with desired bearings code				Part Number
						Roller BRG	Delrin BRG	Sealed Ball BRG	Bronze BRG	
8"	2"	2-3/16"	600	S4	1-3/16"					RS80JB84
		2-7/16"			1/2"	92	56, 12	60		RS80JB**
					5/8"	02				
					3/4"	04, 09	57, 11		B1, B7	
8"	2"	2-7/16"	650	S4	1-7/16"				RS80JB87	
					7/8"	21			RS80JB21	
8"	2-1/2"	2-3/4"	600	C3	1-3/16"				RS80KB84	
		3"			1/2"	92			RS80KB92	
					3/4"	06			RS80KB06	
8"	2-1/2"	2-3/4"	800	S3	1-15/16"				RS80KB85	
					3"	3/4"	93		89	RS80KB**
		1"				23		77		
		1-1/4"				25			RS80KB25	
8"	2-1/2"	3-1/4"	850	C3	1-15/16"				RS80QB85	
		3-1/2"			3/4"	93		69	RS80QB**	
					1"	24	58	R1		78
					1-1/4"	26				RS80QB26
8"	3"	3-1/4"	900	S3	1-15/16"				RS80LB85	
					3/4"	93		69	RS80LB**	
					1"	24	58	R1		78
					1-1/4"	26				RS80LB26
10"	2"	2-3/16"	700	S5	1-3/16"				RS10JB84	
		2-7/16"			1/2"	92	56, 12	60	RS10JB**	
					5/8"	02				
					3/4"	04, 09	57, 11			B1, B7
10"	2"	2-3/16"	750	S5	1-7/16"				RS10JB87	
					7/8"	21			RS10JB21	
10"	2-1/2"	2-3/4"	1000	S5	1-3/16"				RS10KB84	
		3"			1/2"	92			RS80KB92	
					3/4"	06			RS80KB06	
10"	2-1/2"	2-3/4"	1000	S5	1-15/16"				RS10KB85	
					3"	3/4"	93		89	RS10KB**
		1"				23		77		
		1-1/4"				25			RS10KB25	
10"	2-1/2"	3-1/4"	1000	S5	1-15/16"				RS10QB85	
		3-1/2"			3/4"	93		69	RS10QB**	
					1"	24	58	R1		78
					1-1/4"	26				RS10QB26
10"	3"	3-1/4"	1100	S5	1-15/16"				RS10LB85	
		3-1/2"			3/4"	93		69	RS10LB**	
					1"	24	58	R1		78
					1-1/4"	26				RS10LB26
10"	4"	4-1/4"	1200	S5	1-15/16"				RS10NB85	
		4-9/16"			3/4"	93			RS10NB93	
					1"	35			RS10NB35	
					1-1/4"	37			RS10NB37	
10"	4"	4-14"	1400	S5	2-7/16"				RS10NB86	
		4-9/16"			1"	94			RS10NB94	
					1-1/4"	31			RS10NB31	
					1-1/2"	33			RS10NB33	



Wheel Diameter	Tread Width	Hub Length	Load Capacity	Hub Design Type	Bore I.D.	Replace ** with desired bearings code				Part Number	
						Roller BRG	Delrin BRG	Sealed Ball BRG	Bronze BRG		
12"	2.5"	2-3/4"	1000	S5	1-3/16"					RS12KB84	
		3"			1/2"	92				RS12KB92	
					3/4"	06					RS12KB06
12"	2-1/2"	2-3/4"	1200	S5	1-15/16"					RS12KB85	
		3"			3/4"	93		89		RS12KB**	
					1"	23			77		
					1-1/4"	25					RS12KB25
12"	2-1/2"	3-1/4"	1200	S5	1-15/16"					RS12QB85	
		3-1/2"			3/4"	93		69		RS12QB**	
					1"	24	58	R1	78		
					1-1/4"	26					RS12QB26
12"	3"	3-1/4"	1300	S5	1-15/16"					RS12LB85	
		3-1/2"			3/4"	93		69		RS12LB**	
					1"	24	58	R1	78		
					1-1/4"	26					RS12LB26
12"	3-1/2"	4"	1400	C5	2-7/16"					RS12MB86	
						1-1/4"	31		74		RS12MB**
						1-1/2"	33				
12"	4"	4-1/4"	1500	C5	2-7/16"					RS12NB86	
						1-1/4"	31				RS12NB31
						1-1/2"	33				
12"	5"	5-1/4"	2100	C5	2-7/16"					RS12OB86	
						1-1/4"	32				RS12OB32
						1-1/2"	34				
14"	2-1/2"	2-3/4"	1200	S6	1-15/16"					RS14KB85	
		3"			3/4"	93		89		RS14KB**	
		3"			1"	23			77		
		3"			1-1/4"	25					RS114KB25
14"	3"	3-1/4"	1300	S6	1-15/16"					RS14LB85	
		3-1/2"			3/4"	93		69		RS14LB**	
					1"	24	58	R1	78		
					1-1/4"	26					RS14LB26
16"	3"	3-1/4"	1500	S6	1-15/16"					RS16LB85	
		3-1/2"			3/4"	93		69		RS16LB**	
					1"	24	58	R1	78		
					1-1/4"	26					RS16LB26
16"	4"	4-1/4"	2000	S6	2-7/16"					RS16NB84	
						1-1/4"	31				RS16NB31
						1-1/2"	33				
18"	3"	3-1/4"	1550	S6	1-15/16"					RS18LB85	
		3-1/2"			3/4"	93		69		RS18LB**	
					1"	24	58	R1	78		
					1-1/4"	26					RS18LB26

92 & 93 include the spinner.



RUBBER ON NYLON

- Rubber tread vulcanized on Nylon Core
- Rust free with good impact resistance
- Temperature range: -40°F to +180°F
- Durometer Shore A 80(+/-5)

NR60JB04

NR80JB04



Wheel Diameter	Tread Width	Hub Length	Load Capacity	Bore I.D.	Roller BRG	Stainless Roller BRG	Sealed Ball Bearings	Delrin Bearing	Part Number
4"	2"	2-3/16"	400	1-3/16"					NR40JB84
		2-7/16"		1/2"	92 [~]		60	56, 12	NR40JB**
				5/8"	02				
				3/4"	04, 09	05		57, 11	
5"	2"	2-3/16"	400	1-3/16"					NR50JB84
		2-7/16"		1/2"	92 [~]		60	56, 12	NR50JB**
				5/8"	02				
				3/4"	04, 09	05		57, 11	
6"	2"	2-3/16"	400	1-3/16"					NR60JB84
		2-7/16"		1/2"	92 [~]		60	56, 12	NR60JB**
				5/8"	02				
				3/4"	04, 09	05		57, 11	
8"	2"	2-3/16"	400	1-3/16"					NR80JB84
		2-7/16"		1/2"	92 [~]		60	56, 12	NR80JB**
				5/8"	02				
				3/4"	04, 09	05		57, 11	

[~]92 includes the spanner.

MARVEL RUBBER

- Non-marking blue gray tread, with precision ball bearings and thread guard
- Solid rubber vulcanized firmly on plastic core
- Temperature range: -40° F to +160° F
- Durometer: Shore A 85(+/- 5)

TR40GI44

TR50GI44



Wheel Diameter	Tread Width	Hub Length	Load Capacity	Bore I.D.	Tread Color	Part Number
4"	1-1/4"	1-5/8"	300	3/8"	Gray	TR40GI45
5"	1-1/4"	1-5/8"	350	3/8"	Gray	TR50GI45
6"	1-1/4"	1-5/8"	400	3/8"	Gray	TR60GI45

CUSHION RIDE™

- High quality rubber with high modular round tread
- Temperature Range: -20° F to 160°F
- Gray and Black tread available
- Durometer 75 Shore A (+/-5)
- Dual ball bearings

CR60GA42



CR60GI42



Wheel Diameter	Tread Width	Hub Length	Load Capacity	Bore I.D.	Color	Part Number
6"	1-1/4"	1-5/8"	300	3/8"	Gray	CR60GI42
6"	1-1/4"	1-5/8"	300	3/8"	Black	CR60GA42

GRAYROK™

- High-Impact resistance and good floor protection
- Non-Marking Gray w/buffered tread surface
- Temperature range -40° F to 160°F
- Durometer: Shore D 75

RK40HI83



RK40GI82



RK30GI82



RK50GI82



Wheel Diameter	Tread Width	Hub Length	Load Capacity	Bore I.D.	Part Number
2-1/2"	15/16"	1-1/4"	275	5/16"	RK25CI81
3"	13/16"	1-1/64"	130	3/8"	RK30AI82
3"	1"	1-1/4"	130	5/16"	RK30DI81
3"	1-1/4"	1-9/16"	300	3/8"	RK30GI82
4"	1-1/4"	1-9/16"	375	3/8"	RK40GI82
4"	1-1/2"	1-15/16"	400	1/2"	RK40HI83
5"	1-1/4"	1-9/16"	375	3/8"	RK50GI82



HARD RUBBER WHEELS

- Solid hard rubber with nylon sleeve
- Temperature range -40° F to 160°F
- Durometer: Shore D 70(+/- 5)
- Black as standard

HR WHEELS • CAPACITY 500



Wheel Diameter	Tread Width	Hub Length	Load Capacity	Bore I.D.	Replace ** with desired bearings code		Part Number
					Ball Bearing	Delrin Bearing	
2"	3/4"	13/16"	100	5/16"			HR20AB81+
2"	7/8"	1"	125	1/4"			HR20BB80
2"	7/8"	1"	125	5/16"			HR20BB81
2"	7/8"	1"	125	5/16"			HR20AI81
2.5"	7/8"	1"	200	3/8"			HR25AB82
2.5"	7/8"	1"	150	5/16"			HR25BB81
2.5"	15/16"	1-1/4"	150	5/16"			HR25CB81
2.5"	1-1/4"	1-9/16"	275	3/8"			HR25GB82
2.5"	1-1/4"	1-9/16"	275	1/2"			HR25GB83
3"	7/8"	1"	125	1/4"			HR30AB80
3"	13/16"	1"	125	3/8"			HR30AB82+
3"	1"	1-1/4"	125	5/16"			HR30DB81
3"	1-1/4"	1-3/8"	300	1-1/8"			HR30GB98
		1-9/16"	300	3/8"	42	55	HR30GB**
		1-9/16"	300	1/2"		59	
3"	1-1/4"	1-9/16"	300	3/8"			HR30GB82
3"	1-1/4"	1-9/16"	300	3/8"			HR30GI82
3.5"	1-1/4"	1-9/16"	300	3/8"			HR35GB82
4"	1"	1-1/4"	140	5/16"			HR40DB81
4"	1-1/4"	1-3/8"	350	1-1/8"			HR40GB98
		1-9/16"		3/8"	42	55	HR40GB**
				1/2"		59	
4"	1-1/4"	1-9/16"	350	3/8"			HR40GB82
4"	1-1/2"	1-5/8"	400	1/2"			HR40HB83
5"	1"	1-1/4"	145	5/16"			HR50DB81
5"	1-1/4"	1-3/8"	350	1-1/8"			HR50GB98
		1-9/16"		3/8"	42	55	HR50GB**
				1/2"		59	
5"	1-1/4"	1-9/16"	350	3/8"			HR50GB82
5"	1-1/2"	1-5/8"	400	1/2"			HR50HB83
5"	1-21/32"	2"	500	1/2"			HR50PB83

+ Offset hub

SOFT RUBBER WHEELS

- Soft rubber tread over hard rubber core with nylon sleeve
- Durometer: Rubber tread Shore A80(+/-5)
- Temperature range -40° F to 160°F
- Black as standard

SR WHEELS • CAPACITY 400



Wheel Diameter	Tread Width	Hub Length	Load Capacity	Bore I.D.	Replace ** with desired bearings code			Part Number
					Ball Bearing	Roller Bearing	Delrin Bearing	
2"	7/8"	1"	125	1/4"				SR20BB80
2"	7/8"	1"	125	5/16"				SR20BB81
2-1/2"	1-3/32"	1-3/8"	150	5/16"				SR25DB81
2-1/2"	1-1/4"	1-9/16"	275	3/8"				SR25GB82
3"	13/16"	1"	125	1/4"				SR30AB80
3"	13/16"	1"	125	3/8"				SR30AB82+
3"	1"	1-1/4"	125	5/16"				SR30DB81
3"	1-1/4"	1-3/8"	300	1-1/8"				SR30GB98
		1-9/16"	300	3/8"	42		55	SR30GB**
		1-9/16"	300	1/2"			59	
3"	1-1/4"	1-9/16"	300	3/8"				SR30GB82
3"	1-1/4"	1-9/16"	300	1/2"				SR30GB83
3"	1-1/4"	1-9/16"	300	1-1/16"		0A		SR30GB0A
3-1/2"	1-1/4"	1-9/16"	300	3/8"				SR35GB82
3-1/2"	1-1/4"	1-9/16"	300	1/2"				SR35GB83
3-1/2"	1-1/4"	9-1/16"	300	3/4"	42(with decorative disc)			SR35GIDC42
4"	1"	1-1/4"	140	5/16"				SR40DB81
4"	1-1/4"	1-3/8"	350	1-1/8"				SR40GB98
		1-9/16"		3/8"	42		55	SR40GB**
				1/2"			59	
4"	1-1/4"	1-9/16"	350	3/8"				SR40GB82
4"	1-1/2"	1-5/8"	400	1/2"				SR40HB83
5"	1"	1-1/4"	145	5/16"				SR50DB81
5"	1-1/4"	1-3/8"	350	1-1/8"				SR50GB98
		1-9/16"		3/8"	42		55	SR50GB**
				1/2"			59	
5"	1-1/4"	1-1/4"	350	3/8"	42(with decorative disc)			SR50GIDC42
5"	1-1/4"	1-9/16"	350	3/8"				SR50GB82
5"	1-1/2"	1-5/8"	400	5/8"				SR50HB8
5"	1-1/2"	1-5/8"	400	1/2"				SR50HB83
5"	2"	2-7/16"	500	1/2"				SR50JB64



ELEMENT™ WHEEL

- Temperature range -45°F to 180°F intermittent service (120°F continuous)
- Quiet rolling, floor protection, impact resistance and cushion ride
- Round gray tread, high performance wheel
- All wheels equipped with ball bearings
- Hardness 65(+/- 5) Shore A
- Resistance to water
- Non-marking



Wheel Diameter	Tread Width	Hub Length	Load Capacity	Bore I.D.	Part Number
3"	1-1/4"	1-9/16"	300	3/8"	EL30GI43
3-1/2"	1-1/4"	1-9/16"	300	3/8"	EL35GI43
4"	1-1/4"	1-9/16"	320	3/8"	EL40GI43
5"	1-1/4"	1-9/16"	350	3/8"	EL50GI43

ROKHARD™

- Temperature range -45°F to +250°F (with Bronze or High Temp. Max temp. 350°F)
- Glass reinforced polypropylene
- Durometer: Shore D 65 (+/- 5)
- Excellent Chemical resistance
- Slightly crowned tread



Wheel Diameter	Tread Width	Hub Length	Load Capacity	Bore I.D.	Replace ** with desired bearings code			Part Number
					Roller BRG	Precision Ball BRG	Delrin BRG	
3"	1-1/4"	1-9/16"	300	3/8"				HI30GB82
4"	1-1/4"	1-9/16"	400	3/8"				HI40GB82
4"	2"	2-3/16"	800	1-3/16"				HI40JB84
		1/2"		92	62	56, 12		
		5/8"		02				
		3/4"		04, 09		57, 11		
5"	1-1/4"	1-9/16"	450	3/8"				HI50GB82
5"	2"	2-3/16"	900	1-3/16"				HI50JB84
		1/2"		92	62	56, 12		
		5/8"		02				
		3/4"		04, 09		57, 11		
6"	2"	2-3/16"	1000	1-3/16"				HI60JB84
		1/2"		92	62	56, 12		
		5/8"		02				
		3/4"		04, 09		57, 11		
8"	2"	2-3/16"	1100	1-3/16"				HI80JB84
		1/2"		92	62	56, 12		
		5/8"		02				
		3/4"		04, 09		57, 11		



Xtreme™ Wheel

- Highly resistant to water, oils, greases, cleaning compounds, weather and ozone
- Dual sealed precision ball Bearings and Spanner for best performance
- Non-marking, excellent for all floor surfaces
- Provides an off-road rugged aesthetic
- Excellent mobility and wear resistance
- Solid thermo rubber on a plastic core
- Temperature range -20°F - 160°F
- Durometer Shore A 80 (+/-5)

LS,MA WHEELS • CAPACITY 650



Wheel Diameter	Tread Width	Hub Length	Load Capacity	Bore I.D.	Part Number
4	2	2-7/16	400	1/2"	LS40JA62
5	2	2-7/16	500	1/2"	LS50JA62
6	2	2-7/16	600	1/2"	LS60JA62
8	2	2-7/16	700	1/2"	LS80JA62

MAXROK™

- Temperature range: -45°F to 250°F (with bronze or high-temp grease. Max temp 350°C)
- Excellent resistance to grease, oil, most chemical & cleaning solutions
- 30% Glass fiber filled to enhance the impact strength
- Durometer: Shore D 85(+/- 5)





LS, MA WHEELS • CAPACITY 650

Wheel Diameter	Tread Width	Hub Length	Load Capacity	Bore I.D.	Replace ** with desired bearing code					Part Number
					Roller BRG	Precision Ball BRG	Delrin BRG	Sealed Ball Brg	Stainless Sealed Ball BRG	
2"	51/64"	63/64" Offset	200	5/16"						MA20AO81
2"	1-3/4"	1-7/8"	300	15/16"						MA20IB5A
				1/2"	29					MA20IB29
2"	1-3/4"	1-29/32"	300	5/16"						MA20IB81
2-1/2"	1-1/4"	1-9/16"	400	3/8"						MA25GB82
2-1/2"	1-13/16"	2"	800	1-3/16"						MA25IB84
			800	3/4"						MA25IB08
2-1/2"	1-13/16"	2"	800	3/8"						MA25IB83
3"	1-1/4"	1-9/16"	400	3/8"						MA30GB82
				1/2"						MA30GB83
3"	1-13/16"	1-63/64"	1200	1-3/16"						MA30IB84
				3/4"	08					MA30IB08
3"	1-13/16"	2"	1200	1/2"						MA30IB83
3"	1-13/16"	2"	1200	1/2"		49				MA30IB49
3"	1-13/16"	2"	1200	3/8"		62				MA30IB62
3"	1-13/16"	2"	1200	1/2"		63				MA30IB63
3-1/4"	2"	2-3/16"	900	1-3/16"						MA34JB84
		2-7/16"		1/2"	92		56, 12			MA34JB**
				5/8"	02					
				3/4"	04, 09		57, 11	60	6S	
3-1/4"	2"	2-3/16"	900	1/2"						MA34JB83
4"	2"	2-7/16"	900	1/2"		49				MA40JB49
4"	2"	2-3/16"	900	1-3/16"						MA40JB84
		2-7/16"		1/2"	92		56, 12	60	6S	MA40JB**
				5/8"	02					
				3/4"	04, 09		57, 11			
5"	2"	2-7/16"	1000	1/2"		49, 63				MA50JB**
5"	2"	2-3/16"	1000	1-3/16"						MA50JB84
		2-7/16"		1/2"	92		56, 12	60	6S	MA50JB**
				5/8"	02					
				3/4"	04, 09		57, 11			
6"	2"	2-7/16"	1200	1/2"		63				MA60JB63
6"	2"	2-3/16"	1200	1-3/16"						MA60JB84
		2-7/16"		1/2"	92		56, 12	60	6S	MA60JB**
				5/8"	02					
				3/4"	04, 09		57, 11			
8"	2"	2-7/16"	1400	1/2"		49, 63				MA80JB**
8"	2"	2-3/16"	1400	1-3/16"						MA80JB84
		2-7/16"		1/2"	92		56, 12	60	6S	MA80JB**
				5/8"	02					
				3/4"	04, 09		57, 11			
8"	3"	3-1/4"	1900	1-15/16"						MA80LB85
		3-1/2"		3/4"	93	69				MA80LB**
				1"	24	71P	58			
				1-1/4"	26					
10"	2"	2-3/16"	1200	1-3/16"						MA10JB84
		2-7/16"		1/2"	92		56, 11	60	6S	MA10JB**
				5/8"	02					
				3/4"	04, 09		57, 12			



SUPER-SOFT™ WHEEL

- Quiet rolling, floor protection, non-marking
- Gray and black tread color available
- Temperature range -20°F to 180°F
- Durometer Shore A 45(+/- 5)
- Resistance to water
- Round Gray Tread

SF WHEELS • CAPACITY 700

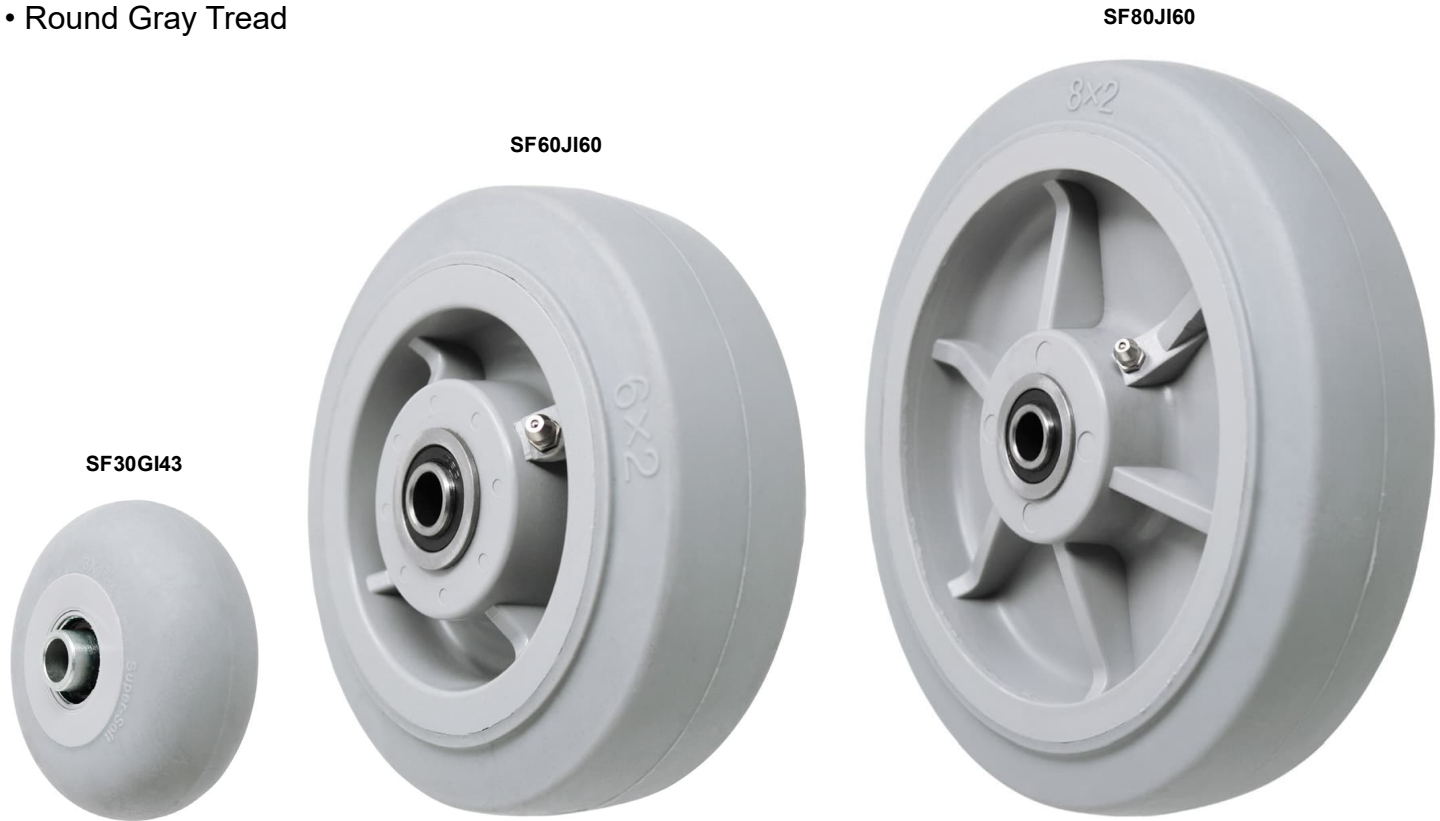

Wheel Dia	Tread Width	Hub Length	Load Capacity	Bore I.D.	Available Color tread/core(+)	Replace ** with desired bearing code						Part Number Replace + with Color Code
						Ball Brg.	Roller Brg.	Stainless Roller Brg.	Prec. Ball Brg.	S.S Prec. Ball Brg.	Delrin Brg./ Sleeve	
3"	1-1/4"	1-9/16"	105	3/8"	Gray	43						SF30GI43
3-1/2"	1-1/4"	1-9/16"	110	3/8"	Gray	43						SF35GI43
4"	1-1/4"	1-9/16"	120	3/8"	Gray	43						SF40GI43
5"	1-1/4"	1-9/16"	125	3/8"	Gray	43						SF50GI43
4"	2"	2-3/16"	300	1-3/16"	Gray							SF40JI84
		1/2"				92		60	S6	56, 12	SF40JI**	
		5/8"				04				13		
		3/4"				04,09	05			57, 11		
5"	2"	2-3/16"	350	1-3/16"	Gray							SF50JI84
		1/2"				92		60	S6	56, 12	SF50JI**	
		5/8"				02				13		
		3/4"				04,09	05			57, 11		
6"	2"	2-3/16"	500	1-3/16"	Gray							SF60J+84
		1/2"				92		60	S6	56, 12	SF60J+**	
		5/8"				02				13		
		3/4"				04, 09	05			57, 11		
8"	2"	2-3/16"	700	1-3/16"	Gray							SF80JI84
		1/2"				92		60	S6	56, 12	SF80JI**	
		5/8"				02				13		
		3/4"				04, 09	05			57, 11		



THERMO-PRO™ WHEEL

- Non-marking thermo rubber tread chemically bonded to polyolefin core
- Resist to cleaning chemicals, acid, alcohol water
- Variety of bearings configurations available
- Gray and black tread color available
- Temperature range -20°F to 180F
- Durometer Shore 75(+/- 5)

TP WHEELS • CAPACITY 950



Wheel Dia	Tread Width	Hub Length	Load Capacity	Bore I.D.	Available Color tread/core(+)	Replace ** with desired bearing code						Part Number Replace + with Color Code	
						Ball Brg.	Roller Brg.	Stainless Roller Brg.	Prec. Ball Brg.	S.S Prec. Ball Brg.	Delrin Brg./ Sleeve		
2"	3/4"	7/8"	70	1/4"	Gray				49			TP200I49	
2"	7/8"	15/16"	75	1/4"	Gray							TP20AI80	
2"	7/8"	1"	75	1/4"	Gray/Beige							TP20BT80	
2"	7/8"	1"	75	5/16"	Gray/Beige							TP20BT81	
3"	7/8"	1"	85	1/4"	Gray/Beige							TP30BT80	
3"	1"	1-1/4"	150	5/16"	Gray/Donut				41			TP30CI41	
3"	1"	1-9/32"	150	5/16"	Gray				41			TP30DI41	
3"	1"	1-3/16"	125	5/16"	H=Gray/Black T=Gray/Beige							TP30D+81	
4"	1"	1-1/8"	140	5/16"	H=Gray/Black T=Gray/Beige							TP40D+81	
4"	1"	1-1/4"	140	5/16"	Gray				41			TP40GI41	
5"	1"	1-1/8"	145	5/16"	H=Gray/Black T=Gray/Beige							TP50D+81	
2-1/2"	1-1/4"	1-5/16"	250	1-1/8"	B=Black/Gray I=Gray/Gray	42					55	TP25G+98	
		1-9/16"		1/2"								59	TP25G+**
2-1/2"	1-1/4"	1-9/16"	250	3/8"	B=Black/Gray I=Gray/Gray				44			TP25G+44	



Wheel Dia	Tread Width	Hub Length	Load Capacity	Bore I.D.	Available Color tread/core(+)	Replace ** with desired bearing code						Part Number Replace + with Color Code
						Ball Brg.	Roller Brg.	Stainless Roller Brg.	Prec. Ball Brg.	S.S Prec. Ball Brg.	Delrin Brg./ Sleeve	
3"	1-1/4"	1-9/16"	250	3/8"	Gray							TP30GI82
3"	1-1/4"	1-9/16"	250	1/2"	T=Gray/Beige/Flat Y=Gray/Beige/Donut							TP30G+83
3"	1-1/4"	1-9/16"	250	3/8"	Gray				44			TP30GI44
3"	1-1/4"	1-9/16"	250	3/8"	T=Gray/Beige/Flat Y=Gray/Beige/Donut				47			TP30G+47
3-1/2"	1-1/4"	1-9/16"	250	1/2"	T=Gray/Beige/Flat Y=Gray/Beige/Donut							TP35G+83
3-1/2"	1-1/4"	1-9/16"	250	3/8"	Gray				44			TP35GI44
3-1/2"	1-1/4"	1-9/16"	250	3/8"	T=Gray/Beige/Flat Y=Gray/Beige/Donut				47			TP35G+47
4"	1-1/4"	1-9/16"	250	1/2"	T=Gray/Beige/Flat Y=Gray/Beige/Donut							TP40G+83
4"	1-1/4"	1-9/16"	250	3/8"	I=Gray/Gray A=Black/Gray				44			TP40G+44
4"	1-1/4"	1-9/16"	250	3/8"	T=Gray/Beige/Flat Y=Gray/Beige/Donut				47			TP40G+47
4"	1-1/4"	1-9/16"	250	3/8"	Gray					4S		TP40GI4S
5"	1-1/4"	1-5/16"	300	1-1/8"	Black/Gray							TP50GA98
		3/8"		42				2S	55	TP50GA**		
		1/2"							59			
5"	1-1/4"	1-9/16"	300	3/8"	Gray/small cap				45			TP50GI45
5"	1-1/4"	1-9/16"	300	3/8"	Gray					4S		TP50GI4S
5"	1-1/4"	1-9/16"	300	1/2"	Gray							TP50GI83
5"	1-1/4"	1-9/16"	300	3/8"	Black/Beige, Donut				47			TP50GZ47
5"	1-1/4"	1-9/16"	300	1/2"	T=Gray/Beige/Flat Y=Gray/Beige/Donut							TP50G+83
5"	1-1/4"	1-9/16"	300	3/8"	I=Gray/Gray A=Black/Gray				44			TP50G+44
5"	1-1/4"	1-9/16"	300	3/8"	Gray/Beige, T=Flat tread, Y=Donut tread				47			TP50G+47
6"	1-1/4"	1-9/16"	300	3/8"	Gray				44			TP60GI44
6"	1-1/4"	1-9/16"	300	3/8"	Gray/small cap				45			TP60GI45
6"	1-1/4"	1-9/16"	300	1/2"	T=Gray/Beige/Flat Y=Gray/Beige/Donut							TP60G+83
6"	1-1/4"	1-9/16"	300	3/8"	Gray/Beige, T=Flat tread, Y=Donut tread				47			TP60G+47
4"	1-1/2"	1-5/8"	280	1-3/16"	Gray							TP40HI84
		1/2"				92		6M	56, 12	TP40HI**		
		5/8"				01						
		3/4"				03			57, 11			
4"	2"	2-3/16"	300	1-3/16"	A=Black/Gray/Flat I=Gray/Gray/Flat T= Gray/Beige/Flat X=Gray/Gray/Donut Y=Gray/Beige/Donut							TP40J+84
		1/2"			92	60	S6	56, 12	TP40J+**			
		5/8"			04			13				
		3/4"			04,09	05		57, 11				
4"	2"	2-7/16"	300	1/2"	Gray/Beige/Flat				63			TP40JT63
4"	2"	2-7/16"	300	1/2"	Gray/Beige/Donut				63, 49			TP40JY**
5"	1-1/2"	1-5/8"	300	1-3/16"	Gray							TP50HI84
		1/2"				92		6M	56, 12	TP50HI**		
		5/8"				01						
		3/4"				03			57, 11			
5"	2"	2-7/16"	350	1/2"	Gray/Gray/Donut				49			TP50JX49
5"	2"	2-3/16"	350	1-3/16"	A=Black/Gray/Flat I=Gray/Gray/Flat T= Gray/Beige/Flat X=Gray/Gray/Donut Y=Gray/Beige/Donut							TP50J+84
		1/2"			92	60	S6	56, 12	TP50J+**			
		5/8"			02			13				
		3/4"			04,09	05		57, 11				



Wheel Dia	Tread Width	Hub Length	Load Capacity	Bore I.D.	Available Color tread/core(+)	Replace ** with desired bearing code						Part Number Replace + with Color Code	
						Ball Brg.	Roller Brg.	Stainless Roller Brg.	Prec. Ball Brg.	S.S Prec. Ball Brg.	Delrin Brg./ Sleeve		
6"	1-1/2"	1-5/8"	375	1-3/16"	Gray							TP60HI84	
		1-7/8"		1/2"			92		6M		56, 12	TP60HI**	
				5/8"			01						
				3/4"			03				57, 11		
6"	2"	2-7/16"	500	1/2"	T=Gray/Beige/Flat X=Gray/Gray/Donut				63			TP60J+63	
6"	2"	2-3/16"	500	1-3/16"	A=Black/Gray/Flat I=Gray/Gray/Flat T= Gray/Beige/Flat X=Gray/Gray/Donut Y=Gray/Beige/Donut								TP60J+84
		2-7/16"		1/2"			92		60	S6	56, 12	TP60J+**	
				5/8"			02				13		
				3/4"			04, 09	05			57, 11		
8"	1-1/2"	2-1/16"	400	1-3/8"	H=Gray/Black T=Gray/Beige								TP80H+95
		2-1/4"		1/2"		51			P1			TP80H+**	
				5/8"		52			P2				
				3/4"		53			P3				
8"	1-1/2"	2"	400	5/8"	Gray/Beige/Flat						DL	TP80HT52DL	
8"	2"	2-7/16"	700	1/2"	T=Gray/Beige/Flat X=Gray/Gray/Donut				63			TP80J+63	
8"	2"	2-3/16"	700	1-3/16"	A=Black/Gray/Flat I=Gray/Gray/Flat T= Gray/Beige/Flat X=Gray/Gray/Donut Y=Gray/Beige/Donut								TP80J+84
		2-7/16"		1/2"			92		60	S6	56, 12	TP80J+**	
				5/8"			02				13		
				3/4"			04, 09	05			57, 11		
8"	2"	2"(Offset)	700	1-3/8"	Black/Gray/Donut								TP80JO95
		2-1/4" (Offset)		1/2"		51			P1			TP80JO**	
				5/8"		52			P2				
				3/4"		53			P3				
8"	2-1/2"	2-3/4"	800	1-15/16"	Gray								TP80KI85
		3"		3/4"					89			TP80KI**	
				1"			23			58			
				1-1/4"			25						
10"	2"	2"(Offset)	700	1-3/8"	Black/Gray/Donut								TP10JO95
		2-1/4" (Offset)		1/2"		51			P1			TP10JO**	
				5/8"		52			P2				
				3/4"		53			P3				
10"	2-1/2"	2-3/4"	850	1-15/16"	Gray								TP10KI85
		3"		3/4"			93		89			TP10KI**	
				1"			23			58			
				1-1/4"			25						
10"	3"	3-1/4"	900	1-15/16"	A=Black G=Gray		24		69		58		TP10L+85
		3-1/2"		3/4"			93		69			TP10L+**	
				1"			24		71P				
				1-1/4"			26						
12"	3"	3-1/4"	950	1-15/16"	Gray								TP12LI85
		3-1/2"		3/4"			93		69			TP12LI**	
				1"			24		71P				
				1-1/4"			26						



NOMADIC™

- Non-marking high grade thermo elastomer tread chemically bonded to a polyolefin core
- Resistance to cleaning chemicals, acids, alcohols and water
- Gray and Black tread color available
- Temperature range -20°F - 180°F
- Durometer Shore A 65(+/- 5)

NM WHEELS • CAPACITY 800

NM10JB52



NM60JX60



NM60JI60



NM50GI43



NM40GB47



Wheel Dia	Tread Width	Hub Length	Load Cap	Bore I.D.	Available Color (+)	Replace ** with desired bearing code						Part Number Replace + with Color Code	
						Dual Sealed Ball BRG	Roller BRG	S.S. Roller BRG	Precision BRG	S.S. Precision BRG	Delrin BRG		
2-1/2"	1-1/4"	1-9/16"	300	3/8"	Gray	42						NM25GI42	
3"	1-1/4"	1-9/16"	300	3/8"	I=Gray/Gray L=Blue/Gray	43						NM30G+43	
3"	1-1/4"	1-9/16"	300	3/8"	Gray					4S		NM30GI4S	
3"	1-1/4"	1-9/16"	300	3/8"	A=Black/Gray I=Gray/Gray L=Blue/Gray						5A	NM30G+5A	
3-1/2"	1-1/4"	1-9/16"	300	3/8"	I=Gray/Gray L=Blue/Gray	43						NM35G+43	
3-1/2"	1-1/4"	1-9/16"	300	3/8"	I=Gray/Gray L=Blue/Gray						5A	NM35G+5A	
4"	1-1/4"	1-9/16"	320	3/8"	Black/Black				47			NM40GB47	
4"	1-1/4"	1-9/16"	320	3/8"	Gray				44			NM40GI44	
4"	1-1/4"	1-9/16"	320	3/8"	Gray					4S		NM40GI4S	
4"	1-1/4"	1-9/16"	320	3/8"	I=Gray/Gray L=Blue/Gray	43						NM40G+43	
4"	1-1/4"	1-9/16"	320	3/8"	I=Gray/Gray L=Blue/Gray						5A	NM40G+5A	
5"	1-1/4"	1-9/16"	350	3/8"	Black/Donut	42						NM50GB42Y	
5"	1-1/4"	1-9/16"	350	3/8"	Gray				44			NM50GI44	
5"	1-1/4"	1-9/16"	350	3/8"	Gray					4S		NM50GI4S	
5"	1-1/4"	1-9/16"	350	3/8"	I=Gray/Gray L=Blue/Gray	43						NM50G+43	
5"	1-1/4"	1-9/16"	350	3/8"	I=Gray/Gray L=Blue/Gray						5A	NM50G+5A	
4"	2"	2-7/16"	400	1/2"	Gray				63			NM40JI63	
4"	2"	2-3/16"	400	1-3/16"	I=Gray/Gray A=Black/Gray	60	92			S6	56, 12	NM40J+84	
				1/2"									
				5/8"									
				3/4"									
5"	2"	2-3/16"	500	1-3/16"	I=Gray/Gray A=Black/Gray	60	92			S6	56, 12	NM50J+84	
				1/2"									
				5/8"									
				3/4"									
6"	2"	2-3/16"	600	1-3/16"	I=Gray/Gray A=Black/Gray	60	92			S6	56, 12	NM60J+84	
				1/2"									
				5/8"									
				3/4"									
6"	2"	2-7/16"	600	1-3/16"	X=Donut/Gray/Gray Z=Donut/Black/Gray	60	92			S6	56, 12	NM60J+84	
				1/2"									
				5/8"									
				3/4"									
8"	2"	2-3/16"	700	1-3/16"	I=Gray/Gray A=Black/Gray	60	92			S6	56, 12	NM80J+84	
				1/2"									
				5/8"									
				3/4"									
8"	2"	2-3/16"	700	1-3/16"	Donut/Gray/Gray	60	92			S6	56, 12	NM80JX84	
				1/2"									
				5/8"									
				3/4"									
10"	2"	2-1/16" Offset	800	1-3/8"	Donut/Black/Gray							NM10JB95	
		2-1/4" Offset		1/2"	Donut/Black/Gray	51, P1							NM10JB**
				5/8"	Donut/Black/Gray	52, P2							
				3/4"	Donut/Black/Gray	53, P3							



SX ELASTOMER™

- Precisely designed elastomer for high performance with heavy weight
- Designed to slow down heat buildup in continuous use
- Temperature Range -40° F to 230° F
- Precision ball bearing as standard
- Durometer Shore D 65 (+/- 5)



Wheel Diameter	Tread Width	Hub Length	Load Capacity	*Bore I.D.	Precision Ball BRG	Stainless Precision Ball BRG	Replace ** with desired bearing code
							Part Number
4"	2"	2-7/16"	1200	1/2	64	72	SX40JI**
5"	2"	2-7/16"	1200	1/2	64	72	SX50JI**
6"	2"	2-7/16"	1400	1/2	64	72	SX60JI**
8"	2"	2-7/16"	1500	1/2	64	72	SX80JI**

IRONMAN™

- 2" Wide wheels have dual 6205 precision bearings, and 2.5" above have quadruple 6205 precision bearings
- Temperature Range -40° F to +250° F and will endure rapid temperature changes
- Compression Molded to its Maximum Strength
- Highly flexible for any customized specification
- Excellent for power tow application
- Machined slight crown tread
- Black Finish but non-marking
- Hardness Shore D 78-82

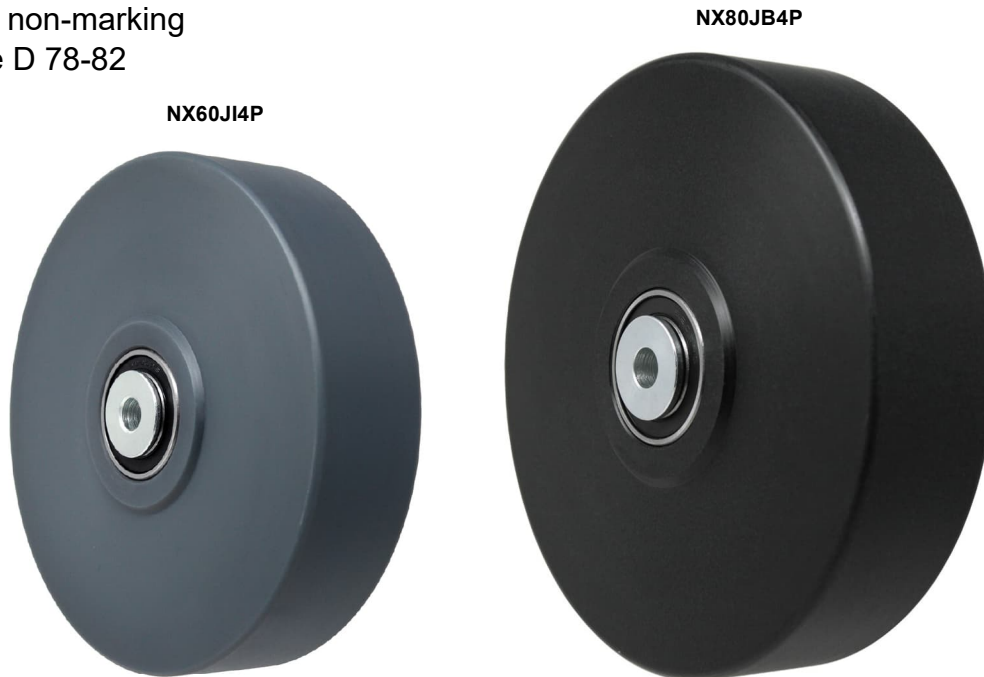



Wheel Dia	Tread Width	Hub Length	Load Capacity	Bore I.D.	Color	Replace ** with desired bearing code							Part Number
						Roller BRG	Stainless Roller BRG	Tapered BRG	Precision Ball BRG	Sealed Ball BRG	Stainless Prec. Ball BRG	Bronze BRG	
2-1/2"	1-27/32"	1-27/32"	1200	1-3/16"	Black								NX25IB84
				3/4"		08, 9A							NX25IB**
2-1/2"	1-31/32"	2-13/64"	1700	1-3/16"	Black								NX29IB84
		2-3/8"		04, 09								NX29IB**	
3"	1-7/8"	1-7/8"	1700	1-3/16"	Black								NX30IB84
				3/4"		08							NX30IB**
3"	1-7/8"	1-7/8"	1600	1/2"	Black				3P~				NX30IB3P
4"	2"	2-3/16"	2200	1-3/16"	Black								NX40JB84
		2-7/16"		1/2"				60	6S			NX40JB**	
		2-7/16"		5/8"		92							
		2-7/16"		3/4"		02							
4"	2"	2-7/16"	2200	1/2"	Black				4P~		S3~		NX40JB**
4"	2"	2-1/16"	2000	1/2"	Gray				4P~				NX40JI4P
5"	2"	2-7/16"	2200	3/4"	Black			70					NX50JB70
								73~					
5"	2"	2-3/16"	2200	1-3/16"	Black								NX50JB84
		2-7/16"		1/2"		92		60	6S			NX50JB**	
		2-7/16"		5/8"		02							
		2-7/16"		3/4"		04, 09							
5"	2"	2-7/16"	2200	1/2"	Black				4P~		S3~		NX50JB**
5"	2"	2-1/16"	2000	1/2"	Gray				4P~				NX50JI4P
5"	3"	3-1/2"	3500	3/4"	Black				5P~		5S~		NX50LB5P
6"	2"	2-7/16"	2200	3/4"	Black			70					NX60JB70
				1/2"			73~						NX60JB73
6"	2"	2-3/16"	2200	1-3/16"	Black								NX60JB84
		2-7/16"		1/2"		92		60	6S			NX60JB**	
		2-7/16"		5/8"		02							
		2-7/16"		3/4"		04, 09							
6"	2"	2-7/16"	2200	1/2"	Black				4P~		S3~		NX60JB**
6"	2"	2-1/16"	2000	1/2"	Gray				4P~				NX60JI4P
6"	2-1/2"	3"	7200	3/4"	Black				5P~				NX60KB5P
6"	3"	3-1/2"	7200	1"	Black				61				NX60LB61
6"	3"	3-1/2"	7200	3/4"	Black				5P~		5S~		NX60LB5P
6"	3"	3-1/2"	7200	1"	Black				7P~				NX60LB7P
8"	2"	2-7/16"	2200	1/2"	Black				63~		S3~		NX80JB**
8"	2"	2-7/16"	2200	1/2"	Black				4P~				NX80JB4P
8"	2"	2-7/16"	2200	3/4"	Black			70					NX80JB70
8"	2"	2-7/16"	2200	1/2"	Black			73~					NX80JB73
8"	2"	2-7/16"	2200	1/2"	Gray				4P~				NX80JI4P
8"	3"	3-1/2"	7000	3/4"	Black				5P~		5S~		NX80LB**
8"	3"	3-1/2"	7000	1"	Black			71	7P~				NX80LB**
8"	3"	3-1/4"	7200	1-15/16"	Black								NX80LB85
		3-1/2"		3/4"		93						78	
				1"		24							
				1-1/4"		26							
8"	4"	4-1/2"	8000	1-1/4"	Black				8P~				NX80NB8P
10"	2-1/2"	3"	6000	3.4"	Black				5P~				NX10KB5P
10"	3"	3-1/2"	7500	3/4"	Black				5P~				NX10LB5P
10"	3"	3-1/2"	7500	1"	Black				7P~				NX10LB7P
10"	4"	4-9/16"	8500	1-1/4"	Black				8P~				NX10NB8P
12"	3"	3-1/2"	7500	3/4"	Black				5P~				NX12LB5P
12"	3"	3-1/2"	7500	1"	Black				7P~				NX12LB7P
12"	4"	4-9/16"	8700	1-1/4"	Black				8P~				NX12NB8P

92 & 93 include spanner

Including top hats.



NYLON

- Excellent resistance to grease, oil, most chemical & cleaning solutions
- Temperature range -40°F - 250°F
- Solid wheel molded from Nylon 6
- High impact resistance strength
- Durometer: Shore D 85 (+/-5)
- Natural Nylon resin color

NY WHEELS • CAPACITY 1300



Wheel Dia	Tread Width	Hub Length	Load Capacity	Bore I.D.	Sealed Ball BRG	SS Ball BRG	Roller BRG	Precision BRG	Delrin BRG	Part Number	
3"	1-1/4"	1-1/8"	300	1-1/8"	42	4S		47	55	NY30GE98	
		1-9/16"		3/8"						NY30GE**	
				1/2"						59	
3"	1-1/4"	1-9/16"	300	1/2"						NY30GE83	
3-1/2"	1-1/4"	1-9/16"	325	1/2"						NY35GE83	
4"	1-1/4"	1-5/16"	350	1-1/8"	42	4S		47	55	NY40GE98	
		1-9/16"		3/8"						NY40GE**	
				1/2"						59	
4"	1-1/4"	1-9/16"	350	1/2"						NY40GE83	
5"	1-1/4"	1-5/16"	500	1-1/8"	42	4S			55	NY50GE98	
		1-9/16"		3/8"						NY50GE**	
				1/2"						59	
5"	1-1/4"	1-9/16"	500	1/2"						NY50GE83	
4"	2"	2-3/16"	800	1-3/16"	60	6S	92		56, 12	NY40JE84	
		2-7/16"		1/2"						02	NY40JE**
				5/8"						04, 09	57, 11
				3/4"							
5"	2"	2-3/16"	900	1-3/16"	60	6S	92		56, 12	NY50JE84	
		2-7/16"		1/2"						02	NY50JE**
				5/8"						04, 09	57, 11
				3/4"							
6"	2"	2-3/16"	1200	1-3/16"	60	6S	92		56, 12	NY60JE84	
		2-7/16"		1/2"						02	NY60JE**
				5/8"						04, 09	57, 11
				3/4"							
6"	2"	2-7/16"	1200	1/2"		72		63		NY60JE63	
8"	2"	2-3/16"	1300	1-3/16"	60	6S	92		56, 12	NY80JE84	
		2-7/16"		1/2"						02	NY80JE**
				5/8"						04, 09	57, 11
				3/4"							
8"	2"	2-7/16"	1300	1/2"		72		63		NY80JE63	



POLYOLEFIN

- Broad selections of wheel and tread design
- Temperature range: -20° F to 180° F
- Excellent chemical resistance
- Non-Marking

PO WHEELS • CAPACITY 900

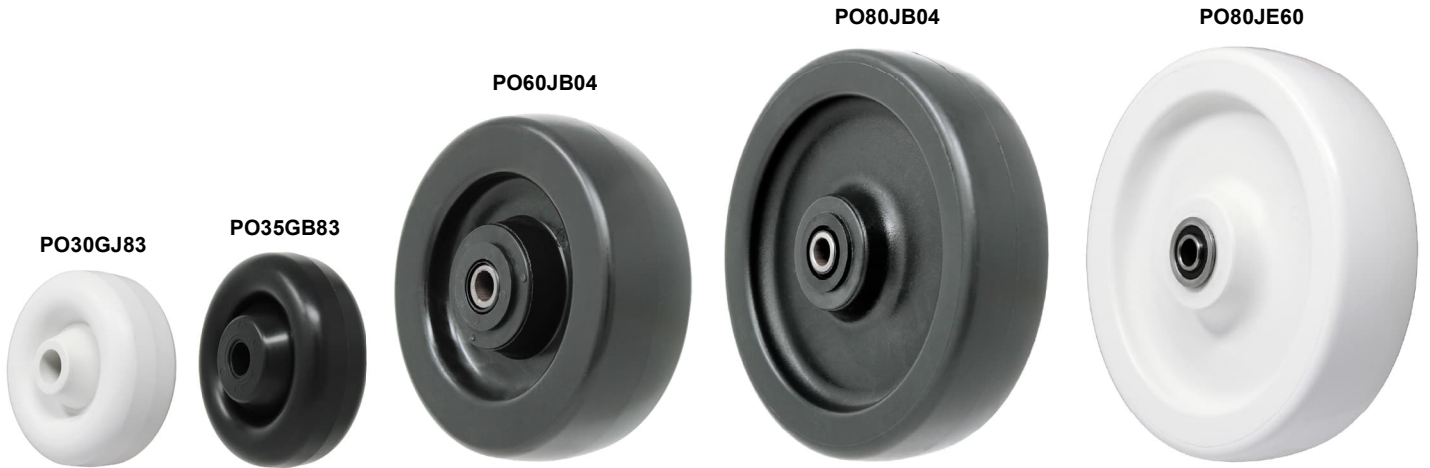

Wheel Dia	Tread Width	Hub Length	Load Capacity	Bore I.D.	Color & Design Code	Replace ** with desired code						Part Number
						Ball BRG	Roller BRG	Stainless Roller BRG	Precision Ball BRG	Stainless Sealed Ball BRG	Delrin BRG	
2"	13/16"	7/8"	80	5/16"	Black							PO20AB81
2"	7/8"	15/16"	100	1/4"	Black							PO20BB80
2"	7/8"	1-1/16"	100	3/8"	Black							PO20AB82
2"	1-3/4"	1-13/16"	300	5/16"	Black							PO20IB81
2-1/2"	15/16"	1-11/32"	175	5/16"	Black							PO25CB81
3"	1"	1-1/8"	175	5/16"	Black							PO30DB81
4"	1"	1-1/8"	220	5/16"	Black							PO40DB81
5"	1"	1-1/8"	230	5/16"	Black							PO50DB81
2-1/2"	1-3/4"	1-29/32"	350	3/8"	Black							PO25IB82
2-1/2"	1-3/4"	1-29/32"	350	1-3/16"	Black							PO25IB84
				1/2"			08				PO25IB08	
3"	1-13/16"	1-63/64"	500	3/8"	Black							PO30IB82
3"	1-13/16"	1-63/64"	500	1/2"	Black							PO30IB83
3"	1-13/16"	1-63/64"	500	1-3/16"	Black							PO30IB84
				3/4"			08				PO30IB08	
3"	1-13/16"	2"	500	1/2"	Black				49			PO30IB49
3"	1-13/16"	2"	500	1/2"	Black				62			PO30IB62
3"	1-13/16"	1-63/64"	500	3/8"	Gray							PO30I82
2-1/2"	1-1/4"	1-9/16"	200	5/16"	Black							PO25GB81
2-1/2"	1-1/4"	1-9/16"	200	3/8"	Black							PO25GB82
2-1/2"	1-1/4"	1-9/16"	200	1/2"	Black							PO25GB83
3"	1-1/4"	1-9/16"	300	3/8"	Black							PO30GB82
3"	1-1/4"	1-9/16"	300	1/2"	White/Donut							PO30GJ83
3"	1-1/4"	1-9/16"	300	3/8"	Black/Donut							PO30GZ82
3"	1-1/4"	1-9/16"	300	1/2"	Black/Donut							PO30GZ83
3"	1-1/4"	1-5/16"	300	1-1/8"	Black/Donut							PO30GZ98
		3/8"		42					55	PO30GZ**		
		1/2"							59			
3"	1-1/4"	1-9/16"	300	3/8"	Black							HP30GB82
3"	1-1/4"	1-9/16"	300	1/2"	Black							HP30GB83
3"	1-1/4"	1-9/16"	300	1/2"	White							HP30GE83
3"	1-1/4"	1-9/16"	300	3/8"	White	42						HP30GE42



Wheel Dia	Tread Width	Hub Length	Load Capacity	Bore I.D.	Color & Design Code	Replace ** with desired code						Part Number
						Ball BRG	Roller BRG	Stainless Roller BRG	Precision Ball BRG	Stainless Sealed Ball BRG	Delrin BRG	
3-1/2"	1-1/4"	1-9/16"	350	1/2"	White							PO35GJ83
3-1/2"	1-1/4"	1-9/16"	350	3/8"	Black							PO35GZ82
3-1/2"	1-1/4"	1-9/16"	350	1/2"	Black							PO35GZ83
3-1/2"	1-1/4"	1-5/16"	350	1-1/8"	Black/Donut							PO35GZ98
		1-9/16"		3/8"		42			55	PO35GZ**		
				1/2"					59			
3-1/2"	1-3/8"	1-1/2"	350	1-1/16"	Black							PO35TZ9R
				1/2"			00				PO35TZ00	
4"	1-7/16"	1-9/16"	350	3/8"	Black							PO40GB82
4"	1-7/16"	1-9/16"	370	3/8"	Black							HP40GB82
4"	1-1/4"	1-9/16"	370	1/2"	White/Donut							PO40GJ83
4"	1-1/4"	1-5/16"	370	1-1/8"	Black/Donut							PO40GZ98
		1-9/16"		3/8"		42			4S	55	PO40GZ**	
				1/2"						59		
4"	1-1/4"	1-9/16"	370	3/8"	Black/Donut							PO40GZ82
4"	1-1/4"	1-9/16"	370	1/2"	Black/Donut							PO40GZ83
5"	1-1/4"	1-5/16"	400	1-1/8"	Black/Donut							PO50GZ98
		1-9/16"		3/8"		42				55	PO50GZ**	
				1/2"						59		
5"	1-1/4"	1-9/16"	400	3/8"	Black							PO51GB82
5"	1-7/16"	1-9/16"	400	3/8"	Black							PO50GB82
5"	1-7/16"	1-9/16"	400	1/2"	Black							PO50GB83
5"	1-1/4"	1-9/16"	400	1/2"	White/Donut							PO50GJ83
5"	1-1/4"	1-9/16"	400	1/2"	Black/Donut							PO50GZ83
5"	1-7/16"	1-9/16"	430	3/8"	Black							HP50GB82
5"	1-7/16"	1-5/16"	430	1-1/8"	Black							HP50GB98
		1-9/16"		3/8"		42				55	HP50GB**	
				1/2"						59		
6"	1-1/4"	1-5/16"	450	1-1/8"	Black/Donut							PO60GZ98
		1-9/16"		3/8"		42				55	PO60GZ**	
		1-9/16"		1/2"						59		
6"	1-1/4"	1-9/16"	450	3/8"	Black/Donut							PO60GZ82
6"	1-1/4"	1-9/16"	450	1/2"	Black/Donut							PO60GZ83
4"	1-1/2"	1-5/8"	375	3/8"	Black							PO40HB82
4"	1-1/2"	1-7/8"	400	1-3/16"	Black							PO40HB84
				1/2"			92		6M	56, 12	PO40HB**	
				5/8"			01					
				3/4"			03			57, 11		
4"	2"	2-3/16"	500	1/2"	Black							PO40JB83
4"	2"	2-3/16"	500	3/4"	Black							PO40JB88
4"	2"	2-7/16"	500	1-3/16"	Black							PO40JB84
				1/2"			92		60	6S	56, 12	PO40JB**
				5/8"			02					
				3/4"			04,09	05			57, 11	
4"	2"	2-3/16"	500	3/4"	White							PO40JE88
4"	2"	2-7/16"	500	1-3/16"	White							PO40JE84
				1/2"			92		60	6S	56, 12	PO40JE**
				5/8"			02					
				3/4"			04,09	05			57, 11	
4"	2"	2-7/16"	500	1-3/8"	White							PO40JE95
				1/2"			51			P1		PO40JE**
				5/8"			52			P2		
				3/4"			53			P3		



PO WHEELS • CAPACITY 900

Wheel Dia	Tread Width	Hub Length	Load Capacity	Bore I. D.	Color & Design Code	Replace ** with desired code						Part Number
						Ball BRG	Roller BRG	Stainless Roller BRG	Precision Ball BRG	Stainless Sealed Ball BRG	Delrin BRG	
5"	1-1/2"	1-5/8"	450	1/2"	Black							PO50HB83
5"	1-1/2"	1-5/8"	450	3/4"	Black							PO50HB88
5"	1-1/2"	1-5/8"	450	1-3/16"	Black							PO50HB84
		1/2"				92		6M		56, 12	PO50HB**	
		5/8"				01						
		3/4"				03				57, 11		
5"	2"	2-3/16"	650	3/4"	Black							PO50JB88
5"	2"	2-3/16"	650	1-3/16"	Black							PO50JB84
		1/2"				92		60	6S	56, 12	PO50JB**	
		5/8"				02						
		3/4"				04,09	05			57, 11		
5"	2"	2-3/16"	500	3/4"	White							PO50JE88
5"	2"	2-3/16"	500	1-3/16"	White							PO50JE84
		1/2"				92		60	6S	56, 12	PO50JE**	
		5/8"				02						
		3/4"				04,09	05			57, 11		
5"	2"	2-3/16"	500	1-3/8"	White							PO50JE95
		1/2"		51				P1		PO50JE**		
		5/8"		52				P2				
		3/4"		53				P3				
6"	1-1/2"	1-5/8"	450	1/2"	Black							PO60HB83
6"	1-1/2"	1-5/8"	450	1-3/16"	Black							PO60HB84
		1/2"				92		6M		56, 12	PO60HB**	
		5/8"				01						
		3/4"				03				57, 11		
6"	1-1/2"	1-5/8"	450	1/2"	White							PO60HE83
6"	2"	2-3/16"	700	1/2"	Black							PO60JB83
6"	2"	2-3/16"	700	3/4"	Black							PO60JB88
6"	2"	2-3/16"	700	1-3/16"	Black							PO60JB84
		1/2"				92		60	6S	56, 12	PO60JB**	
		5/8"				02						
		3/4"				04,09	05			57, 11		
6"	2"	2-3/16"	700	3/4"	White							PO60JE88
6"	2"	2-3/16"	700	1-3/16"	White							PO60JE84
		1/2"				92		60	6S	56, 12	PO60JE**	
		5/8"				02						
		3/4"				04,09	05			57, 11		
6"	2"	2-3/16"	700	1-3/8"	White							PO60JE95
		1/2"		51				P1		PO60JE**		
		5/8"		52				P2				
		3/4"		53				P3				
8"	2"	2-3/16"	900	3/4"	Black							PO80JB88
8"	2"	2-3/16"	900	1-3/16"	Black							PO80JB84
		1/2"				92		60	6S	56, 12	PO80JB**	
		5/8"				02						
		3/4"				04,09	05			57, 11		
8"	2"	2-3/16"	900	3/4"	White							PO80JE88
8"	2"	2-3/16"	900	1-3/16"	White							PO80JE84
		1/2"				92		60	6S	56, 12	PO80JE**	
		5/8"				02						
		3/4"				04,09	05			57, 11		
8"	2"	2-3/16"	900	1-3/8"	White							PO80JE95
		1/2"		51				P1		PO80JE**		
		5/8"		52				P2				
		3/4"		53				P3				

VIGOROK™

- Resist hard impact cracking/chipping, salt, cleaning solutions, solvents, oils, fats, petroleum and water
- Temperature range -45°F - 180°F continuous operation (250° F intermittent)
- Engineered polymer for high load capacity
- Non-marking and easy rolling
- Gray as standard color
- Durometer 85(+/- 5)
- Steam cleanable

VK WHEELS • CAPACITY 2200

VK80JE6S

VK60JB6S



Wheel Diameter	Tread Width	Hub Length	Load Capacity	Bore I.D.	Replace ** with desired bearings code					Part Number
					Sealed Ball BRG	SS Ball BRG	Roller BRG	Precision BRG	Delrin BRG	
3"	2"	2"	1200	1-3/16"						VK40JE84
		2-1/4"		1/2"	60	6S	92	56, 12	VK40JE**	
				5/8"			02			
				3/4"			04, 09	57, 11		
4"	2"	2-3/16"	1400	1-3/16"					VK40JE84	
		2-7/16"		1/2"	60	6S	92	56, 12	VK40JE**	
				5/8"			02			
				3/4"			04, 09	57, 11		
5"	2"	2-3/16"	1500	1-3/16"					VK50JE84	
		2-7/16"		1/2"	60	6S	92	56, 12	VK50JE**	
				5/8"			02			
				3/4"			04, 09	57, 11		
6"	2"	2-3/16"	2000	1-3/16"					VK60JE84	
		2-7/16"		1/2"	60	6S	92	56, 12	VK60JE**	
				5/8"			02			
				3/4"			04, 09	57, 11		
8"	2"	2-3/16"	2200	1-3/16"					VK80JE84	
		2-7/16"		1/2"	60	6S	92	56, 12	VK80JE**	
				5/8"			02			
				3/4"			04, 09	57, 11		



PHENOLIC

- Canvas fiber filled Phenolic for high impact resistance
- Temperature range: -50° F to +250° F
- Durometer: Shore D 90(+/-5)

PH80JB60

PH60JB60

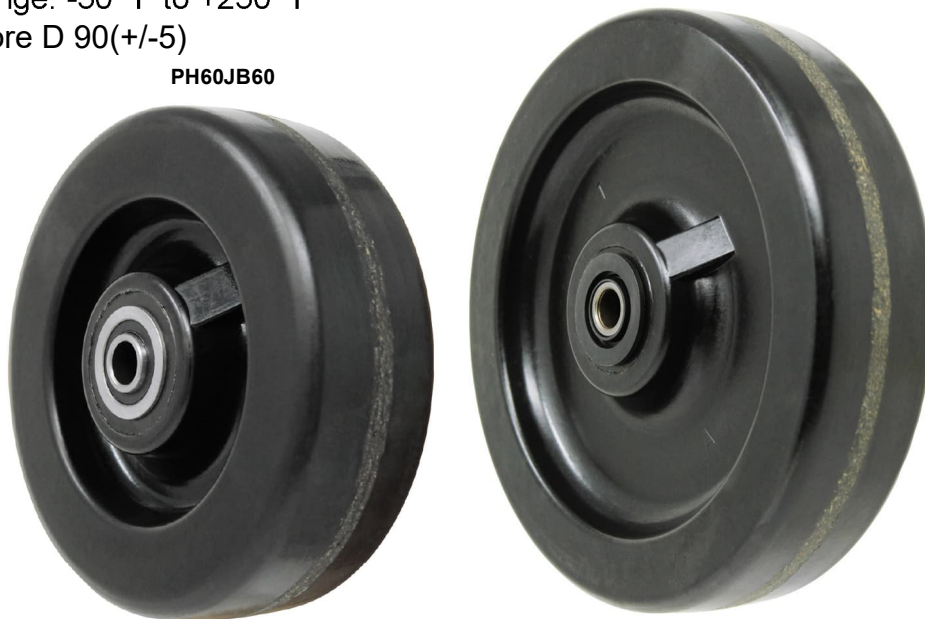

PH WHEELS • CAPACITY 3500

Wheel Diameter	Tread Width	Hub Length	Load Capacity	Bore I.D.	Replace ** with desired bearings code				Part Number
					Roller BRG	Precision Ball BRG	Delrin BRG	Bronze BRG	
3"	1-1/4"	1-3/8"	300	1/2"					PH30GB83
3"	1-1/4"	1-3/8"	300	1-1/16"					PH30GB5P
3"	1-1/4"	1-3/8"	300	1/2"	00				PH30GB00
3-1/2"	1-1/4"	1-3/8"	350	1/2"					PH35GB83
4"	1-1/4"	1-3/8"	300	1/2"					PH40GB83
4"	1-1/4"	1-3/8"	400	1-1/16"					PH40GB5P
4"	1-1/4"	1-3/8"	400	1/2"	00				PH40GB00
5"	1-1/4"	1-3/8"	450	1/2"					PH50GB83
3"	1-3/4"	1-7/8"	1000	1-3/16"					PH30IB84
3"	1-3/4"	1-7/8"	1000	1/2"	92~				MA30IB92
3"	1-3/4"	1-7/8"	1000	3/4"	36				PH30IB36
3"	1-1/2"	1-5/8"	600	1/2"					PH30HB83
3"	1-1/2"	1-5/8"	600	1-3/16"					PH30HB84
3"	1-1/2"	1-7/8"	600	1/2"	92~	6M	12, 56		PH30HB**
3"	1-1/2"	1-7/8"	600	5/8"	01				PH30HB**
3"	1-1/2"	1-7/8"	600	3/4"	03		11, 57		PH30HB**
3-1/4"	1-1/2"	1-5/8"	600	1-3/16"					PH34HB84
3-1/4"	1-1/2"	1-7/8"	600	1/2"	92~	6M	12, 56		PH34HB**
3-1/4"	1-1/2"	1-7/8"	600	5/8"	01				PH34HB**
3-1/4"	1-1/2"	1-7/8"	600	3/4"	03		11, 57		PH34HB**
4"	1-1/2"	1-5/8"	600	1/2"					PH40HB83
4"	1-1/2"	1-5/8"	600	3/4"					PH40HB88
4"	1-1/2"	1-5/8"	600	1-3/16"					PH40HB84
4"	1-1/2"	1-7/8"	600	1/2"	92~	6M	12, 56		PH40HB**
4"	1-1/2"	1-7/8"	600	5/8"	01				PH40HB**
4"	1-1/2"	1-7/8"	600	3/4"	03		11, 57		PH40HB**
5"	1-1/2"	1-5/8"	600	1/2"					PH50HB83
5"	1-1/2"	1-5/8"	600	1-3/16"					PH50HB84
5"	1-1/2"	1-7/8"	600	1/2"	92~	6M	12, 56		PH50HB**
5"	1-1/2"	1-7/8"	600	5/8"	01				PH50HB**
5"	1-1/2"	1-7/8"	600	3/4"	03		11, 57		PH50HB**
6"	1-1/2"	1-5/8"	800	1-3/16"					PH60HB84
6"	1-1/2"	1-7/8"	800	1/2"	92~	6M	12, 56		PH60HB**
6"	1-1/2"	1-7/8"	800	5/8"	01				PH60HB**
6"	1-1/2"	1-7/8"	800	3/4"	03		11, 57		PH60HB**
3-1/4"	2"	2-3/16"	700	1-3/16"					PH34JB84
3-1/4"	2"	2-7/16"	700	1/2"	92~		12,56		PH34JB**
3-1/4"	2"	2-7/16"	700	5/8"	02				PH34JB**
3-1/4"	2"	2-7/16"	700	3/4"	04, 09	60, 6S	11, 57	B1, B5	PH34JB**



Wheel Diameter	Tread Width	Hub Length	Load Capacity	Bore I.D.	Replace ** with desired bearings code				Part Number
					Roller BRG	Precision Ball BRG	Delrin BRG	Bronze BRG	
4"	2"	2-3/16"	800	1-3/16"					PH40JB84
		2-7/16"		1/2"	92~		12,56		PH40JB**
				5/8"	02				
				3/4"	04, 09	60, 6S	11, 57	B1, B5	
4"	2" (Straight-sided)	2-3/16"	1000	1-3/16"					PH40TB84
		2-7/16"		1/2"	92~		12,56		PH40TB**
				5/8"	02				
				3/4"	04, 09	60, 6S	11, 57	B1, B5	
5"	2"	2-3/16"	100	3/4"					PH50JB88
5"	2"	2-3/16"	1000	1-3/16"					PH50JB84
		2-7/16"		1/2"	92~		12,56		PH50JG**
				5/8"	02				
				3/4"	04, 09	60, 6S	11, 57	B1, B5	
5"	2" (Straight-sided)	2-3/16"	1200	1-3/16"					PH50TB84
		2-7/16"		1/2"	92~		12,56		PH50TB**
				5/8"	02				
				3/4"	04, 09	60, 6S	11, 57	B1, B5	
6"	2"	2-3/16"	1200	3/4"				B1, B5	PH60JB88
6"	2"	2-3/16"	1200	1-3/16"					PH60JB84
		2-7/16"		1/2"	92~		12,56		PH60JB**
				5/8"	02				
				3/4"	04, 09	60, 6S	11, 57	B1, B5	
6"	2" (Straight-sided)	2-3/16"	1500	1-3/16"					PH60TB84
		2-7/16"		1/2"	92~		12,56		PH60TB**
				5/8"	02				
				3/4"	04, 09	60, 6S	11, 57	B1, B5	
6"	2-1/2"	2-3/4"	1400	1-3/16"					PH60KB84
		3"		1/2"	92~				PH60KB**
				3/4"	06				
6"	2-1/2"	2-3/4"	1600	1-15/16"					PH60KB85
		3"		3/4"	93~	89			PH60KB**
				1"	23			B7	
				1-1/4"	25				
6"	2-1/2"	3-1/4"	1600	1-15/16"					PH60QB85
		3-1/2"		3/4"	93	69			PH60QB**
				1"	24	R1	58	B8	
				1-1/4"	26				
6"	3"	3-1/4"	2000	1-15/16"					PH60LB85
		3-1/2"		3/4"	93~	69			PH60LB**
				1"	24	R1	58	B8	
				1-1/4"	26				



Wheel Diameter	Tread Width	Hub Length	Load Capacity	Bore I.D.	Replace ** with desired bearings code				Part Number
					Roller BRG	Precision Ball BRG	Delrin BRG	Bronze BRG	
8"	2"	2-3/16"	1400	1-3/16"					PH80JB84
		2-7/16"		1/2"	92~		12,56		PH80JB**
				5/8"	02				
				3/4"	04, 09	60, 6S	11, 57	B1, B5	
8"	2-1/2"	2-3/4"	1800	1-3/16"				PH80KB84	
		3"		1/2"	92~			PH80KB**	
				3/4"	06				
8"	2-1/2"	3"	2000	1-15/16"				PH80KB85	
				3/4"	93~	89		PH80KG**	
				1"	23		B7		
				1-1/4"	25				
8"	2-1/2"	3-1/4"	2000	1-15/16"				PH80QB85	
		3-1/2"		3/4"	93~	69		PH80QB**	
				1"	24	R1	58		B8
				1-1/4"	26				
8"	3"	3-1/4"	2500	1-15/16"				PH80LB85	
		3-1/2"		3/4"	93~	69		PH80LB**	
				1"	24	R1	58		B8
				1-1/4"	26				
8"	3" Straight Sided	3-1/2"	2500	1-15/16"				PH80LT85	
				3/4"	93~	69		PH80LT**	
				1"	24	R1	58	B8	PH80LT**
				1-1/4"	26			PH80LT**	
10"	2-1/2"	2-3/4"	2200	1-3/16"				PH10KB84	
		3"		1/2"	92~			PH10KB**	
				3/4"	06				
10"	2-1/2"	3"	2500	1-15/16"				PH10KB85	
				3/4"	93~	89		PH10KB**	
				1"	23		B7		
				1-1/4"	25				
10"	2-1/2"	3-1/4"	2500	1-15/16"				PH10QB85	
		3-1/2"		3/4"	93~	69		PH10QB**	
				1"	24	R1	58		B8
				1-1/4"	26				
10"	3"	3-1/4"	2900	1-15/16"				PH10LB85	
		3-1/2"		3/4"	93~	69		PH10LB**	
				1"	24	R1	58		B8
				1-1/4"	26				
12"	2-1/2"	3"	3000	1-15/16"				PH12KB85	
				3/4"	93~	89		PH12KB**	
				1"	23		B7		
				1-1/4"	25				
12"	2-1/2"	3-1/4"	3000	1-15/16"				PH12QB85	
		3-1/2"		3/4"	93~			PH12QB**	
				1"	24	R1	58		B8
				1-1/4"	26				
12"	3"	3-1/2"	3500	1-15/16"				PH12LB85	
				3/4"	93~	69		PH12LB**	
				1"	24	R1	58		B8
				1-1/4"	26				
12"	3.5"	4-1/4"	4000	2-7/16"				PH12MB86	
		4-9/16"		1-1/4"	31			PH12MB31	
				1-1/2"	33			PH12MB33	
12"	4" Straight-sided	4"	6500	2-7/16"				PH12NB86	
				1-1/2"	39			PH12NB39	
16"	3"	4-1/4"	4000	2-7/16"				PH16LB86	
		4-9/16"		1-1/4"	31			PH16LB31	
				1-1/2"	33			PH16LB33	
16"	4"	5-1/4"	8000	2-7/16"				PH16NB86	
				1-1/4"	32			PH16NB32	
				1-1/2"	34			PH16NB34	
18"	3"	3-1/4"	3500	1-15/16"				PH18LB85	
		3-1/2"		3/4"	93~	69		PH18LB**	
				1"	24	R1	58		B8
				1-1/4"	26				

~includes
spanner

CONDUCTIVE THERMO RUBBER WHEEL

- Compounded with a special metal fiber to ensure the sufficient conductivity through the life of the wheel
- Surface resistance > 1×10^3 but < $1 \times 10^5 \Omega/\text{square}$ (It exceeds Federal ESD Standard, FF-C-88C)
- Wheels equipped with precision bearing
- Durometer: Shore A 95(+/-5)
- Non-Marking



Wheel Diameter	Wheel Width	Hub Length	Load Capacity	Bore I.D.	Part #
3"	1-1/4"	1-9/16"	200	3/8"	CN30GH44
4"	1-1/4"	1-9/16"	250	3/8"	CN40GH44
5"	1-1/4"	1-9/16"	275	3/8"	CN50GH44

The conductive wheels must be properly installed to ensure a conductive path from the equipment leg, through the caster, axle and bearing and then through the center core and tread

CONDUCTIVE SOLID RUBBER WHEEL

- Surface resistance > 1×10^3 but < $1 \times 10^5 \Omega/\text{square}$ (It exceeds Federal ESD Standard, FF-C-88C)
- Temperature range -40° F to 160°F
- Durometer: Shore D 70(+/- 5)
- Black as standard



Wheel Diameter	Tread Width	Hub Length	Load Capacity	Bore I.D.	Replace ** with desired bearing code		Part Number
					Ball Bearing	Delrin Bearing	
3"	1"	1-1/4"	125	1/4"			CT30DB80
3"	1"	1-1/4"	125	5/16"			CT30DB81
3"	1-1/4"	1-3/8"	300	1-1/8"			CT30GB98
		1-9/16"	300	3/8"	42	55	CT30GB**
		1-9/16"	300	1/2"		59	



CX,CY WHEELS • CAPACITY 700

STATIC DISSIPATIVE POLYURETHANE ON ALUMINUM CORE

- Surface resistance > 1×10^6 but < $1 \times 10^9 \Omega/\text{square}$
- Wheels equipped with precision bearing
- Durometer: Shore A 85(+/-5)
- Non-Marking



Wheel Diameter	Wheel Width	Hub Length	Load Capacity	Bore I.D.	Part #
4"	2"	2-7/16"	500	1/2"	CX40JL63
5"	2"	2-7/16"	540	1/2"	CX50JL64
6"	2"	2-7/16"	600	1/2"	CX60JL64
8"	2"	2-7/16"	700	1/2"	CX80JL64

The conductive wheels must be properly installed to ensure a conductive path from the equipment leg, through the caster, axle and bearing and then through the center core and tread

CONDUCTIVE NYLON WHEEL

- Surface resistance > 1×10^3 but < $1 \times 10^5 \Omega/\text{square}$ (It exceeds Federal ESD Standard, FF-C-88C)
- Wheels equipped with precision bearing
- Durometer: Shore D 85(+/-5)
- Non-Marking

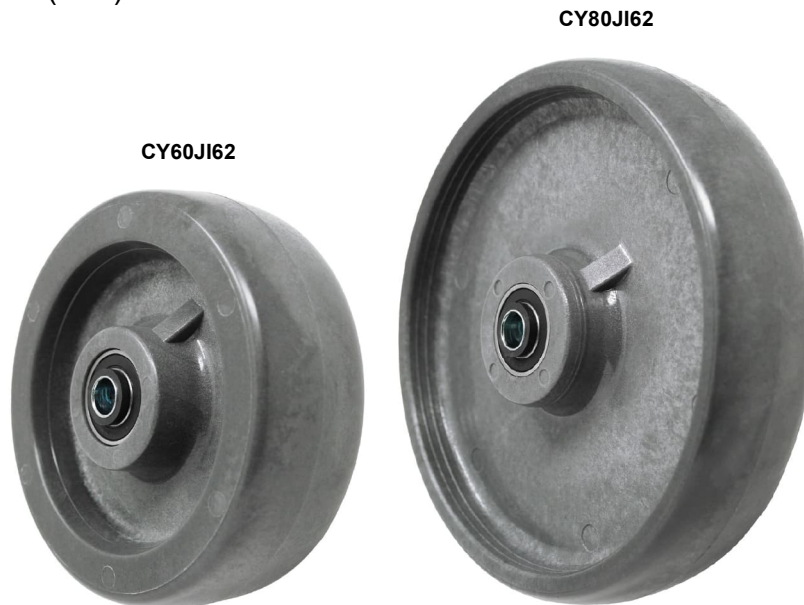

Wheel Diameter	Wheel Width	Hub Length	Load Capacity	BORE I.D.	Part #
4"	2"	2-7/16"	500	1/2"	CY40JI62
5"	2"	2-7/16"	540	1/2"	CY50JI62
6"	2"	2-7/16"	600	1/2"	CY60JI62
8"	2"	2-7/16"	700	1/2"	CY80JI62

The conductive wheels must be properly installed to ensure a conductive path from the equipment leg, through the caster, axle and bearing and then through the center core and tread



RETORT

- Highly resistant to water, oils, petroleum products, salt solutions, common cleaning solutions, solvents and acid
- Made from heat stabilized polymer for excellent weight capacity and heat resistance
- Rounded tread for exceptionally easy rolling
- Temperature range: -20° F to 300° F
- Durometer Shore D 85(+/-5)
- Autoclavable

AC WHEELS • CAPACITY 900



Wheel Diameter	Tread Width	Hub Length	Load Capacity	Bore I.D.	Replace ** with desired code					Part Number
					Roller BRG	Stainless Roller BRG	Precision Ball BRG	Stainless Sealed Ball BRG	Delrin BRG	
3"	1-1/2"	1-5/8"	325	1/2"						AC30HE83
3-1/2"	1-1/4"	1-3/8"	350	1/2"						AC35GE83
4"	1-1/4"	1-3/8"	350	1/2"						AC40GE83
5"	1-1/4"	1-3/8"	450	1/2"						AC40GE83
4"	1-1/2"	1-5/8"	375	1/2"						AC40HE83
4"	2"	2-3/16"	600	3/4"						AC40JE88
4"	2"	2-7/16"	600	1-3/16"						AC40JE84
				1/2"	92	60	6S	56, 12	AC40JE**	
				5/8"	02					
				3/4"	04,09	05		57, 11		
5"	1-1/2"	1-5/8"	550	1/2"					AC50HE83	
5"	2"	2-3/16"	650	3/4"						AC50JE88
5"	2"	2-7/16"	650	1-3/16"						AC50JE84
				1/2"	92	60	6S	56, 12	AC50JE**	
				5/8"	02					
				3/4"	04,09	05		57, 11		
6"	2"	2-3/16"	650	3/4"						AC60JE88
6"	2"	2-7/16"	700	1-3/16"						AC60JE84
				1/2"	92	60	6S	56, 12	AC60JE**	
				5/8"	02					
				3/4"	04,09	05		57, 11		
8"	2"	2-3/16"	900	3/4"						AC80JE88
8"	2"	2-7/16"	900	1-3/16"						AC80JE84
				1/2"	92	60	6S	56, 12	AC80JE**	
				5/8"	02					
				3/4"	04,09	05		57, 11		



BF/SL WHEELS • CAPACITY 450

STEROLIZER® WHEEL

- Stainless Steel core for corrosive, wash down and clean environment and aluminum core for bakeries
- Exceptional resistance to water, oil grease, most acids, chemicals and cleaning solutions
- Special engineered elastomer offers cushioned, quiet ride and excellent floor protection
- Temperature range: -40° F to 350° continuous 6 hours, 400°F intermittent
- Exclusively engineered non-Silicon Rubber
- Durometer: 65 Shore A (+/- 5)
- BG wheel has a glass filled nylon hub

SL40HC61



BG50V02S



BF50HC61



Wheel Diameter	Tread Width	Hub Length	Load Capacity	Bore ID	Core Material	Type of Bearing	Part Number
4"	1-1/4"	1-9/16"	300	1/2"	Aluminum	Plain	BF40GC83
4"	1-1/2"	1-5/8"	350	3/8"	Aluminum	S.S. Precision	BF40HC61
4"	1-1/4"	1-9/16"	300	1/2"	Stainless	Plain	SL40GC83
4"	1-1/2"	1-5/8"	350	3/8"	Stainless	S.S. Precision	SL40HC61
5"	1-3/8"	1-9/16"	325	3/8"	Glass Filled Nylon	S.S. ball bearing	BG50V02S
5"	2"	2-3/16"	450	1/2"	Stainless	Bronze Bushing	SL50JCB8

BRIMSTONE®

- Temperature range: -40° to 425°F Continuous, 475°F to 550°F intermittent
- Brown as standard color; Black is available on certain sizes
- Excellent for autoclave and steam cleaning applications
- Made out of exclusively engineered polymer
- Superior abrasion and impact resistance
- Durometer 85 shore D (+/- 5)

GN40HB83



GN60JQ09



GN80LQ85





Wheel Dia	Tread Width	Hub Length	Load Capacity	Available color (+)	Bore I.D.	Replace ** with desired bearing code							Part Number Replace "+" with color code
						Top Hat Spanner	Stainless Top Hat Spanner	Roller BRG	Stainless Roller BRG	Seal Ball BRG	Stainless Sealed Ball BRG	Bronze BRG	
3"	1-1/4"	1-13/32"	300	Q=Brown B=Black	1/2"								GN30G+83
		1-21/32"			3/8"	99	97					GN30G+**	
3"	1-1/2"	1-5/8"	600	Brown	1/2"								GN30HQ83
3"	1-1/2"	1-5/8"	600	Brown	3/4"								GN30HQ88
3-1/2"	1-1/4"	1-13/32"	600	Brown	1/2"								GN35GQ83
		1-24/32"			3/8"	99	97					GN35GQ**	
4"	1-1/4"	1-13/32"	300	Q=Brown B=Black	1/2"								GN40G+83
		1-24/32"			3/8"	99	97					GN40G+**	
5"	1-1/4"	1-13/32"	700	Q=Brown B=Black	1/2"								GN50G+83
		1-12/32"			3/8"	99	97					GN50G+**	
4"	1-1/2"	1-5/8"	700	Q=Brown B=Black	1/2"								GN40H+83
4"	1-1/2"	1-5/8"	700	Q=Brown B=Black	3/4"								GN40H+88
4"	1-1/2"	1-5/8"	700	Brown	1-3/16"								GN40HQ84
		1-7/8"			1/2"		92~		6M				GN40HQ**
					5/8"		01						
					3/4"		03						
4"	2"	2-3/16"	800	Brown	3/4"							GN40JQ88	
4"	2"	2-3/16"	800	Brown	1-3/16"								GN40JQ84
		2-7/16"			1/2"		92~		60	6S			GN40JQ**
					5/8"		02						
					3/4"		04	05		B1, B5			
5"	1-1/2"	1-5/8"	800	Brown	1/2"							GN50HQ83	
5"	1-1/2"	1-5/8"	800	Brown	3/4"							GN50HQ88	
5"	2"	2-3/16"	1000	Brown	3/4"								GN50JQ88
5"	2"	2-3/16"	1000	Q=Brown B=Black	1-3/16"								GN50J+84
		2-7/16"			1/2"		92~		60	6S			GN50J+**
					5/8"		02						
					3/4"		04	05		B1, B5			
6"	2"	2-3/16"	1100	Brown	3/4"							GN60JQ88	
6"	2"	2-3/16"	1000	Q=Brown B=Black	1-3/16"								GN60J+84
		2-7/16"			1/2"		92~		60	6S			GN60J+**
					5/8"		02						
					3/4"		04	05		B1, B5			
8"	2"	2-3/16"	1100	Brown	3/4"							GN80JQ88	
8"	2"	2-3/16"	1000	Q=Brown B=Black	1-3/16"								GN80J+84
		2-7/16"			1/2"		92~		60	6S			GN80J+**
					5/8"		02						
					3/4"		04	05		B1, B5			
8"	3"	3-1/4"	2000	Brown	1-15/16"								GN80LQ85
		3-1/2"			3/4"		92~		69			GN80LQ**	
					1"		24	41	71P		B8		
					1-1/4"		26						

~including
spanner
bushing



HIGH-TEMP PHENOLIC

- Temperature range -40° F to 475° F Continuous, 525° F Intermittent
- Phenolic resin filled with fiber glass for high-temperature resistance
- Durometer Shore D 95 (+/-5)

HT60TQ84

HT40HQ83



HT WHEELS • CAPACITY 3000

Wheel Dia	Tread Width	Hub Length	Load Capacity	Bore I.D.	Replace ** with desired bearing code							Part Number
					Top Hat Spanner	Stainless Top Hat Spanner	Roller BRG	Stainless Roller BRG	Sealed Precision Ball BRG	Stainless Sealed Precision Ball BRG	Bronze BRG	
3"	1-1/4"	1-3/8"	200	1/2"								HT30GQ83
		1-2"		3/8"	99	97					HT30GQ**	
4"	1-1/4"	1-3/8"	250	1/2"								HT40GQ83
		1-2"		3/8"	99	97					HT40GQ**	
5"	1-1/4"	1-3/8"	300	1/2"								HT50GQ83
		1-2"		3/8"	99	97					HT50GQ**	
3-1/2"	1-1/2"	1-5/8"	400	1-3/16"								HT34HQ84
		1-7/8"		1/2"		92~		6M				HT30HQ**
				5/8"		01						
				3/4"		03						
4"	1-1/2"	1-5/8"	400	1/2"							HT40HQ83	
4"	1-1/2"	1-5/8"	400	3/4"							HT40HQ88	
4"	1-1/2"	1-5/8"	400	1-3/16"								HT40HQ84
		1-7/8"		1/2"		92~		6M				HT40HQ**
				5/8"		01						
				3/4"		03						
4"	2"	2-3/16"	600	3/4"							HT40HQ88	
4"	2"	2-3/16"	600	1-3/16"								HT40JQ84
		2-7/16"		1/2"		92~		60	6S			HT40JQ**
				5/8"		02						
				3/4"		04	05			B1, B5		
5"	2"	2-3/16"	750	1-3/16"								HT50JQ84
		2-7/16"		1/2"		92~		60	6S			HT50JQ**
				5/8"		02						
				3/4"		04	05			B1, B5		



Wheel Dia	Tread Width	Hub Length	Load Capacity	Bore I.D.	Replace ** with desired bearing code							Part Number
					Top Hat Spanner	Stainless Top Hat Spanner	Roller BRG	Stainless Roller BRG	Sealed Precision Ball BRG	Stainless Sealed Precision Ball BRG	Bronze BRG	
6"	2"	2-3/16"	900	1-3/16"								HT60JQ84
		2-7/16"		1/2"			92~		60	6S		HT60JQ**
				5/8"			02					
				3/4"			04	05			B1, B5	
6"	2" (Straight-sided)	2-3/16"	1100	1-3/16"								HT60TQ84
		2-7/16"		1/2"			92~		60	6S		HT60TQ**
				5/8"			02					
				3/4"			04	05			B1, B5	
6"	2-1/2"	2-3/4"	1200	1-15/16"								HT60KQ85
		3"		3/4"			93~					HT60KQ93
				1"			23					HT60KQ23
				1-1/4"			25					HT60KQ25
6"	3"	3-1/4"	1500	1-15/16"								HT60LQ85
		3-1/2"		3/4"			93~		69			HT60LQ**
				1"			24	41	71P		B8	
				1-1/4"			26					
8"	2"	2-3/16"	1100	1-3/16"								HT80JQ84
		2-7/16"		1/2"			92~		60	6S		HT80JQ**
				5/8"			02					
				3/4"			04	05			B1, B5	
8"	2-1/2"	2-3/4"	1300	1-15/16"								HT80KQ85
		3"		3/4"			93~					HT80KQ93
				1"			23					HT80KQ23
				1-1/4"			25					HT80KQ25
8"	3"	3-1/4"	1800	1-15/16"								HT80LQ85
		3-1/2"		3/4"			93~		69			HT80LQ**
				1"			24	41	71P		B8	
				1-1/4"			26					
10"	3"	3-1/4"	2100	1-15/16"								HT10LQ85
		3-1/2"		3/4"			93~		69			HT10LQ**
				1"			24	41	71P		B8	
				1-1/4"			26					
12"	3"	3-1/4"	2600	1-15/16"								HT12LQ85
		3-1/2"		3/4"			93~		69			HT12LQ**
				1"			24	41	71P		B8	
				1-1/4"			26					
12"	3-1/2"	4-1/4"	3000	2-7/16"								HT12MQ86
		4-9/16"		1-1/4"			31					HT12MQ31
				1-1/2"			33					HT12MQ33

Disclaimer: not recommend for steam washer or any high humidity environment

~including spanner bushing



EPOXY Wheel

- Perfect wheels for both dry and moisturized high temperature environment
- Best impact resistance in both dry and moisturized temperature
- Temperature Range -40° F to +480° F
- Glass fiber mixed with Epoxy Resin
- Excellent Ergonomic

OV WHEELS • CAPACITY 2600



Wheel Dia	Tread Width	Hub Length	Load Capacity	Bore I.D.	Sealed Ball BRG	Stainless Sealed Ball BRG	Roller BRG	Stainless Roller BRG	Bronze BRG	Part Number	
4"	1-1/2"	1-5/8"	700	1/2"						OV40HQ83	
4"	1-1/2"	1-5/8"	700	3/8"					B6	OV40HQ76	
4"	1-1/2"	1-5/8"	700	3/4"						OV40HQ88	
4"	1-1/2"	1-5/8"	700	1-3/16"						OV40HQ84	
		1-7/18"		1/2"	6M		92~			OV40HQ**	
				5/8"			01				
				3/4"			03				
4"	2"	2-3/16"	800	1-3/16"						OV40JQ84	
		2-7/16"		1/2"	60	6S	92~			OV40JQ**	
				5/8"			02				
				3/4"			04	05	B5, B1		
5"	2"	2-3/16"	1000	1-3/16"						OV50JQ84	
		2-7/16"		1/2"	60	6S	92~			OV50JQ**	
				5/8"			02				
6"	2"	2-3/16"	1100	3/4"						OV60JQ88	
		2-7/16"		1-3/16"						OV60JQ84	
				1/2"	60	6S	92~			OV60JQ**	
				5/8"			02				
8"	2"	2-7/16"	1200	3/4"						OV80JQ84	
				1-3/16"						OV80JQ**	
				1/2"	60	6S	92~				
				5/8"			02				
8"	3"	3-1/2"	1900	3/4"						OV80LQ85	
				1-1/4"	1-15/16"						OV80LQ**
					3/4"	69		93~			
					1"	71P		24	41	B8	
10"	3"	3-1/2"	2400	1-1/4"						OV10LQ85	
				1-1/4"	1-15/16"						OV10LQ**
					3/4"	69		93~			
					1"	71P		24	41	B8	
12"	3"	3-1/2"	2600	1-1/4"						OV12LQ85	
				1-1/4"	1-15/16"						OV12LQ**
					3/4"	69		93~			
					1"	71P		24	41	B8	

~including spanner bushing

ANTIMICROBIAL THERMO RUBBER WHEEL

- Suppresses the growth of various microbes including bacteria, fungi, mildew, molds and more
- Applications of medical equipment, food processing, pharmaceutical, cleaning and more
- Antimicrobial additive mixed in the polymer and lasts through the life of the wheel
- Resistance to cleaning chemicals, acids, alcohols and water
- Non-marking high grade thermo elastomer tread
- Temperature range -20°F - 180°F
- Durometer Shore A 70 (+/- 5)

AM50GI4S



Wheel Diameter	Wheel Width	Hub Length	Load Capacity	Bore I.D.	Bearing Type	Part #
3"	1-1/4"	1-9/16"	200	3/8"	Delrin	AM30GN4S
3"	1-1/4"	1-9/16"	200	3/8"	Pre. Ball	AM30GN82
3-1/2"	1-1/4"	1-9/16"	200	3/8"	Delrin	AM35GN4S
3-1/2"	1-1/4"	1-9/16"	200	3/8"	Pre. Ball	AM35GN82
4"	1-1/4"	1-9/16"	250	3/8"	Delrin	AM40GN82
4"	1-1/4"	1-9/16"	250	3/8"	Pre. Ball	AM40GN82
5"	1-1/4"	1-9/16"	275	3/8"	Delrin	AM50GN4S
5"	1-1/4"	1-9/16"	275	3/8"	Pre. Ball	AM50GN82

*AM wheel does not eliminate the need of cleaning practice.

UTILITY HEAT™ WHEEL

- Specifically engineered material for autoclave application with 15 PSI steam pressure, 250° F for 15 - 20 minutes or 29 PSI steam pressure, 273° F for 6 minutes.
- Plain bore to avoid contamination during Autoclavable Process
- Soft tread for quiet and smooth ride
- Corrosion resistant and Autoclavable
- Durometer Shore A 75(+/-5)

UT50GR44



Wheel Diameter	Wheel Width	Hub Length	Load Capacity	Bore I.D.	Bearing Type	Part #
3"	1-1/4"	1-9/16"	200*	3/8"	Delrin	UT30GI82
3-1/2"	1-1/4"	1-9/16"	225*	3/8"	Delrin	UT35GI82
4"	1-1/4"	1-9/16"	300*	3/8"	Delrin	UT40GI82
5"	1-1/4"	1-9/16"	350*	3/8"	Delrin	UT50GR5A
6"	1-1/4"	1-9/16"	350*	3/8"	Delrin	UT60GI82

* Load capacity at room Temperature



SINTERED IRON

- Temperature range: -40° F to +500° F
- Heat treated Sintered iron
- Hardness: Brinell 145

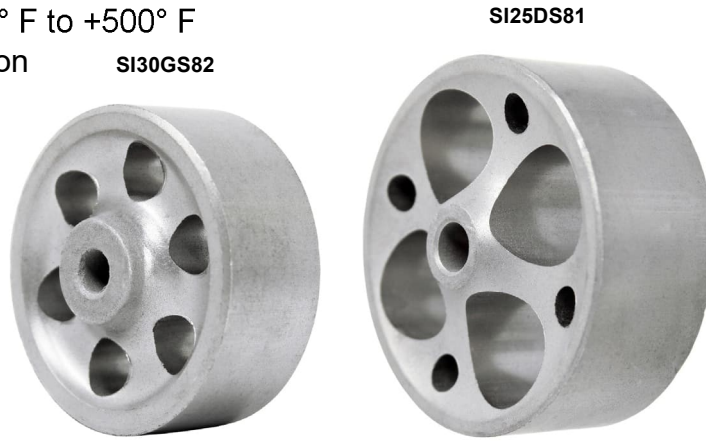

Wheel Diameter	Tread Width	Hub Length	Load Capacity	Bore I.D.	Part Number
2"	7/8"	1"	200	1/4"	SI20CS80
2.5"	1"	1-3/8"	250	5/16"	SI25DS81
3"	1-1/4"	1-9/16"	350	3/8"	SI30GS82

SEMI-STEEL WHEEL

- Precisely machined Semi-Steel wheels
- Temperature range: -45°F to 800°F
- Tensile strength of 30,000PSI
- Hardness: Brinell 145

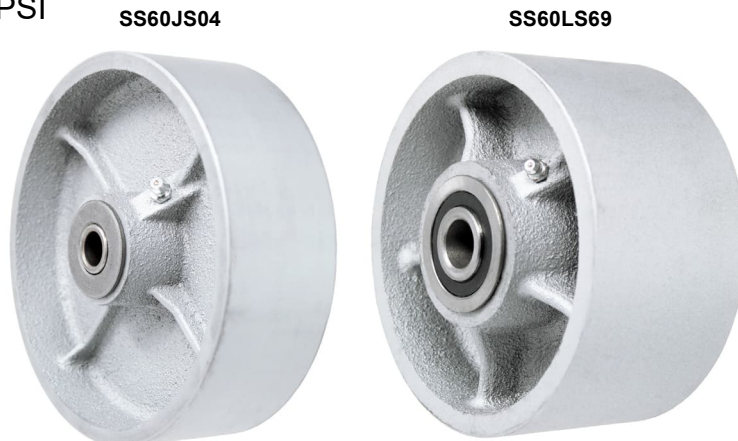

Wheel Dia	Tread Width	Hub Length	Load Capacity	Hub Design type	Bore I.D.	Replace ** with desired bearing code				Part Number
						Roller BRG	Sealed Ball BRG	Delrin BRG	Bronze BRG	
2"	1"	1-1/8"	250	C	1/4"					SS20DS80
2-1/2"	1"	1-1/8"	250	C	5/16"					SS25DS81
3"	1-1/4"	1-9/16"	350	C3	3/8"					SS30GS82
3"	1-1/4"	1-9/16"	350	C3	1/2"					SS30GS83
3-1/2"	1-1/4"	1-9/16"	400	C3	3/8"					SS35GS82
4"	1-1/4"	1-9/16"	350	C3	3/8"					SS40GS82
4"	1-1/4"	1-9/16"	350	C3	1/2"					SS40GS83
5"	1-1/4"	1-9/16"	350	C3	3/8"					SS50GS82
5"	1-1/4"	1-9/16"	350	C3	1/2"					SS50GS83
3-1/4"	1-1/2"	1-5/8"	400	C	1-3/16"					SS34HS84
		1-7/8"			1/2"	92~	6M	12, 56	SS34HS**	
					5/8"	01				
					3/4"	03		11, 57		
3-1/4"	2"	2-3/16"	700	C	1-3/16"					SS34JS84
		2-7/16"			1/2"	92~	60	12, 56	SS34JS**	
					5/8"	02				
					3/4"	04, 09		11, 57		B1, B5
4"	1-1/2"	1-5/8"	600	C4	1/2"				SS40HS83	
4"	1-1/2"	1-5/8"	600	C4	1-3/16"					SS40HS84
		1-7/8"			1/2"	92~	6M	12, 56	SS40HS**	
					5/8"	01				
					3/4"	03		11, 57		
4"	2"	2-3/16"	700	C3	1-3/16"					SS40JS84
		2-7/16"			1/2"	92~	60	12, 56	SS40JS**	
					5/8"	02				
					3/4"	04, 09		11, 57		B1, B5



Wheel Dia	Tread Width	Hub Length	Load Capacity	Hub Design type	Bore I.D.	Replace ** with desired bearing code				Part Number
						Roller BRG	Sealed Ball BRG	Delrin BRG	Bronze BRG	
5"	1-1/2"	1-5/8"	600	C4	1-3/16"					SS50HS84
		1-7/8"			1/2"	92~	6M	12, 56		SS50HS**
					5/8"	01				
					3/4"	03		11, 57		
5"	2"	2-3/16"	1000	C	1-3/16"					SS50JS84
		2-7/16"			1/2"	92~	60	12, 56		SS50JS**
					5/8"	02				
					3/4"	04, 09		11, 57	B1, B5	
6"	1-1/2"	1-5/8"	600	C5	1-3/16"					SS60HS84
		1-7/8"			1/2"	92~	6M	12, 56		SS60HS**
					5/8"	01				
					3/4"	03		11, 57		
6"	2"	2-3/16"	1000	C4	1-3/16"					SS60JS84
		2-7/16"			1/2"	92~	60	12, 56		SS60JS**
					5/8"	02				
					3/4"	04, 09		11, 57	B1, B5	
6"	2-1/2"	2-3/4"	1600	C5	1-3/16"	92~				SS60KS84
		3"				06				SS60KS06
6"	2-1/2"	2-3/4"	1800	C5	1-15/16"					SS60KS85
		3"			3/4"	93~	89			SS60KS**
					1"	23		58	B7	
					1-1/4"	25				
6"	2-1/2"	3-1/4"	1800	S4	1-15/16"					SS60QS85
		3-1/2"			3/4"	93~	69			SS60QS**
					1"	24	71P		B8	
					1-1/4"	26				
6"	3"	3-1/4"	2700	C5	1-15/16"					SS60LS85
		3-1/2"			3/4"	93~	69			SS60LS**
					1"	24	71P		B8	
					1-1/4"	26				
8"	2"	2-3/16"	1400	C6	1-3/16"					SS80JS84
		2-7/16"			1/2"	92~	60	12, 56		SS80JS**
					5/8"	02				
					3/4"	04, 09		11, 57	B1, B5	
8"	2-1/2"	2-3/4"	1600	S6	1-3/16"	92~				SS80KS84
		3"				06				SS80KS06
8"	2-1/2"	2-3/4"	1800	S6	1-15/16"					SS80KS85
		3"			3/4"	93~	89			SS80KS**
					1"	23		58	B7	
					1-1/4"	25				
8"	2-1/2"	3-1/4"	1800	S6	1-15/16"					SS80QS85
		3-1/2"			3/4"	93~	69			SS80QS**
					1"	24	71P		B8	
					1-1/4"	26				
8"	3"	3-1/4"	2500	S6	1-15/16"					SS80LS85
		3-1/2"			3/4"	93~	69			SS80LS**
					1"	24	71P		B8	
					1-1/4"	26				
10"	2-1/2"	2-3/4"	1700	S5	1-3/16"	92~				SS10KS84
		3"				06				SS10KS06
10"	2-1/2"	2-3/4"	2000	S5	1-15/16"					SS10KS85
		3"			3/4"	93~	89			SS10KS**
					1"	23		58	B7	
					1-1/4"	25				
10"	2-1/2"	3-1/4"	2000	S5	1-15/16"					SS10QS85
		3-1/2"			3/4"	93~	69			SS10QS**
					1"	24	71P		B8	
					1-1/4"	26				
10"	3"	3-1/4"	2500	S5	1-15/16"					SS10LS85
		3-1/2"			3/4"	93~	69			SS10LS**
					1"	24	71P		B8	
					1-1/4"	26				
12"	2-1/2"	2-3/4"	2000	S5	1-15/16"					SS12KS85
		3"			3/4"	93~	89			SS12KS**
					1"	23		58	B7	
					1-1/4"	25				
12"	2-1/2"	3-1/4"	2000	S5	1-15/16"					SS12QS85
		3-1/2"			3/4"	93~	69			SS12QS**
					1"	24	71P		B8	
					1-1/4"	26				
12"	3"	3-1/4"	2500	S5	1-15/16"					SS12LS85
		3-1/2"			3/4"	93~	69			SS12LS**
					1"	24	71P		B8	
					1-1/4"	26				

~ including spanner bushing



HEAVY-DUTY SEMI-STEEL

- Heavy duty Semi-Steel wheel for higher capacity applications
- Seal Precision bearings are available for better mobility

HS80JS04

HS60JS04



HS WHEELS • CAPACITY 1400

Wheel Diameter	Tread Width	Hub Length	Load Capacity	Hub Design type	Bore I.D.	Replace ** with desired bearing code					Part Number
						Roller BRG	Sealed Ball BRG	Precision Ball BRG	Delrin BRG	Bronze BRG	
4"	2"	2-3/16"	900	C4	1-3/16"						HS40JS84
		2-7/16"			1/2"	92~	60		56, 12		HS40JS**
					5/8"	02					
					3/4"	04,09			57, 11	B5, B1	
4"	2"	2-7/16"	900	C4	1/2"			63		HS40JS63	
5"	2"	2-3/16"	1200	S4	1-3/16"						HS50JS84
		2-7/16"			1/2"	92~	60		56, 12		HS50JS**
					5/8"	02					
					3/4"	04,09			57, 11	B5, B1	
5"	2"	2-7/16"	1200	S4	1/2"			63		HS50JS63	
6"	2"	2-3/16"	1400	S6	1-3/16"						HS60JS84
		2-7/16"			1/2"	92~	60		56, 12		HS60JS**
					5/8"	02					
					3/4"	04,09			57, 11	B5, B1	
6"	2"	2-7/16"	1400	S6	1/2"			63		HS60JS63	
6"	2" (Crown tread)	2-3/16"	1400	S6	1-3/16"						HS60JX84
		2-7/16"			1/2"	92~	60		56, 12		HS60JX**
					5/8"	02					
					3/4"	04,09			57, 11	B5, B1	
8"	2"	2-3/16"	1400	S6	1-3/16"						HS80JS84
		2-7/16"			1/2"	92~	60		56, 12		HS80JS**
					5/8"	02					
					3/4"	04,09			57, 11	B5, B1	
8"	2"	2-7/16"	1400	S6	1/2"			63		HS80JS63	
8"	2" (Crown tread)	2-3/16"	1400	S6	1-3/16"						HS80JX84
		2-7/16"			1/2"	92~	60		56, 12		HS80JX**
					5/8"	02					
					3/4"	04,09			57, 11	B5, B1	

~including spanner bushing



DUCTILE STEEL

- Made out of Ductile Iron, Extra thick walled, heavy-duty core, hub and tread
- Variety of bearing options for optimal performance at different applications
- Temperature range: -45°F to 800°F (with bronze bearing)
- Tensile strength of 45,000PSI

DS10LR70

DS60JR04



DS WHEELS • CAPACITY 17000

Wheel Diameter	Tread Width	Hub Length	Load Capacity	Bore I.D.	Replace ** with desired bearing code					Part Number
					Roller BRG	Tapered Roller BRG	Precision Ball BRG	Delrin BRG	Bronze BRG	
4"	1-1/2"	2"	1200	1-3/16"						DS40HR84
				1/2"	92~					DS40HR92
				3/4"	08					DS40HR08
4"	2"	2-3/16"	1500	1-3/16"						DS40JR84
		2-7/16"		1/2"	92~		60	12, 56		DS40JR**
				5/8"	02					
				3/4"	04,09		11, 57	B1, B5		
4"	2'	2-7/16"	1500	1/2"			63		DS40JR63	
5"	2"	2-3/16"	1500	1-3/16"						DS50JR84
		2-7/16"		1/2"	92~		60	12, 56		DS50JR**
				5/8"	02					
				3/4"	04,09		11, 57	B1, B5		
5"	2"	2-7/16"	1500	1/2"			63		DS50JR63	
5"	2-1/2"	2-3/4"	2000	1-15/16"						DS50KR85
		3"		3/4"	93~		89			DS50KR**
				1"	23			B7		
				1-1/4"	25					



Wheel Diameter	Tread Width	Hub Length	Load Capacity	Bore I.D.	Replace ** with desired bearing code					Part Number
					Roller BRG	Tapered Roller BRG	Precision Ball BRG	Delrin BRG	Bronze BRG	
6"	2"	2-3/16"	2000	1-3/16"						DS60JR84
		2-7/16"		1/2"	92~		60	12, 56		DS60JR**
				5/8"	02					
6"	2"	2-7/16"	2000	1/2"			63			DS60JR63
6"	2"	2-7/16"	2000	1/2"		73				DS60JR73
6"	2-1/2"	2-3/4"	3500	1-15/16"						DS60KR85
		3"		3/4"	93~		89			DS60KR**
				1"	23			B7		
				1-1/4"	25					
6"	2-1/2"	3"	3500	3/4"		70			DS60KR70	
6"	2-1/2"	3"	3500	1"		71			DS60KR71	
6"	2-1/2"	3-1/4"	3500	1-15/16"						DS60QR85
		3-1/2"		3/4"	93~		69			DS60QR**
				1"	24		71P		B8	
				1-1/4"	26					
6"	3"	3-1/4"	6000	1-15/16"						DS60LR85
		3-1/2"		3/4"	93~		69			DS60LR**
				1"	24		71P	58	B8	
				1-1/4"	26					
6"	3"	3-1/2"	8000	3/4"		70			DS60LR70	
6"	3"	3-1/2"	8000	1"		71			DS60LR71	
8"	2"	2-3/16"	2300	1-3/16"						DS80JR84
		2-7/16"		1/2"	92~		60	12, 56		DS80JR**
				5/8"	02					
8"	2"	2-7/16"	2300	3/4"	04,09			11, 57	B1, B5	DS80JR**
8"	2-1/2"	2-3/4"	4000	1-15/16"						DS80KR85
		3"		3/4"	93~		89			DS80KR**
				1"	23			B7		
				1-1/4"	25					
8"	2-1/2"	3"	4000	3/4"		70			DS80KR70	
8"	2-1/2"	3-1/4"	4000	1-15/16"						DS80QR85
2-1/2"	3-1/2"	3/4"		93~		69			DS80QR**	
	1"	24			71P		B8			
	1-1/4"	26								
8"	3"	3-1/4"	6000	1-15/16"						DS80LR85
		3-1/2"		3/4"	93~		69			DS80LR**
				1"	24		71P	58	B8	
				1-1/4"	26					
8"	3"	3-1/2"	6000	3/4"		65			DS80LR65	
8"	3"	3-1/2"	6000	1"		67			DS80LR67	
8"	3"	3-1/2"	10000	3/4"		70			DS80LR70	
8"	4"	4-1/4"	10000	2-7/16"						DS80NR86
		4-9/16"		1-1/4"	31					DS80NR31
				1-1/2"	33					DS80NR33
8"	4"	4-9/16"	17000	1-1/4"		74			DS80NR74	
8"	4"	4-9/16"	10000	1"			67		DS80NR67	
10"	2-1/2"	2-3/4"	4500	1-15/16"						DS10KR85
		3"		3/4"	93~		89			DS10KR**
				1"	23			B7		
				1-1/4"	25					
10"	2-1/2"	3"	4500	3/4"		70			DS10KR70	
10"	2-1/2"	3-1/4"	4500	1-15/16"						DS10QR85
		3-1/2"		3/4"	93~		69			DS10QR**
				1"	24		71P	58	B8	
				1-1/4"	26					
10"	3"	3-1/4"	6000	1-15/16"						DS10LR85
		3-1/2"		3/4"	93~		69			DS10LR**
				1"	24		71P	58	B8	
				1-1/4"	26					
10"	3"	3-1/2"	10000	3/4"		70			DS10LR70	
10"	3"	3-1/2"	10000	1"		71			DS10LR71	
10"	4"	4-1/4"	10000	2-7/16"						DS10NR86
		4-9/16"		1-1/4"	31					DS10NR31
				1-1/2"	33					DS10NR33
10"	4"	4-9/16"	10000	1"			67		DS10NR67	
10"	4"	4-9/16"	17000	1-1/4"		74			DS10NR74	
12"	3"	3-1/4"	6000	1-15/16"						DS12LR85
		3-1/2"		3/4"	93~		69			DS12LR**
				1"	24		71P	58	B8	
				1-1/4"	26					
12"	3"	3-1/4"	10000	3/4"		70			DS12LR70	
12"	3"	3-1/4"	10000	1"		71			DS12LR71	
12"	3-1/2"	4-1/4"	10000	1-1/4"		74			DS12MR74	
12"	4"	4-9/16"	17000	1-1/4"		74			DS12NR74	
14"	3"	3-1/4"	6000	1-15/16"						DS14LR85
		3-1/2"		3/4"	93~		69			DS14LR**
				1"	24		71P	58	B8	
				1-1/4"	26					
14"	3"	3-1/2"	10000	1-1/4"		71			DS14LR71	

~including spanner bushing



ENERGY SAVER DUCTILE™

- Various bearings options for optimal performance at different applications
- Temperature range: -45°F to 800°(with bronze bearing)
- Extra thick walled, heavy-duty core, hub and tread face
- Tensile Strength of 45,000 PSI
- Slightly crowned tread

CD WHEELS • CAPACITY 10000

CD10LR71



CD40JR04



Wheel Diameter	Tread Width	Hub Length	Lead Capacity	Bore I.D.	Replace ** with desired bearing code					Part Number
					Roller BRG	Tapered Roller BRG	Sealed Ball BRG	Delrin BRG	Bronze BRG	
4"	2"	2-3/16"	1500	1-3/16"						CD40JR84
		2-7/16"		1/2"	92~		60	12,56		CD40JR**
				5/8"	02					
				3/4"	04,09			11,57	B1, B5	
5"	2"	2-3/16"	1500	1-3/16"					CD50JR84	
		2-7/16"		1/2"	92~		60	12,56		CD50JR**
				5/8"	02					
				3/4"	04,09			11,57	B1, B5	



Wheel Diameter	Tread Width	Hub Length	Lead Capacity	Bore I.D.	Replace ** with desired bearing code					Part Number
					Roller BRG	Tapered Roller BRG	Sealed Ball BRG	Delrin BRG	Bronze BRG	
6"	2"	2-3/16"	2000	1-3/16"						CD60JR84
		2-7/16"		1/2"	92~		60	12,56		CD60JR**
				5/8"	02					
				3/4"	04,09			11,57	B1, B5	
6"	2"	2-7/16"	2000	3/4"		70			CD60JR70	
6"	2"	2-7/16"	2000	1/2"		73			CD60JR73	
6"	2-1/2"	2-3/4"	3500	1-15/16"						CD60KR85
		3"		3/4"	93~		89			CD60KR**
				1"	23				B7	
				1-1/4"	25					
6"	2-1/2"	3"	3500	1"		71			CD60KR71	
6"	2-1/2"	3"	3500	3/4"		70			CD60KR70	
6"	2-1/2"	3-1/4"	3500	1-15/16"						CD60QR85
		3-1/2"		3/4"	93~		69			CD60QR**
				1"	24		71P		B8	
				1-1/4"	26					
6"	3"	3-1/4"	6000	1-15/16"						CD60LR85
		3-1/2"		3/4"	93~		69			CD60LR**
				1"	24		71P		B8	
				1-1/4"	26					
6"	3"	3-1/2"	10000	3/4"			5P		CD60LR5P	
6"	3"	3-1/2"	10000	3/4"		70			CD60LR70	
6"	3"	3-1/2"	10000	1"		71			CD60LR71	
8"	2"	2-3/16"	2000	1-3/16"						CD80JR84
		2-7/16"		1/2"	92~		60	12,56		CD80JR**
				5/8"	02					
				3/4"	04,09			11,57	B1, B5	
8"	2"	2-7/16"	2000	3/4"		70			CD80JR70	
8"	2-1/2"	2-3/4"	4000	1-15/16"						CD80KR85
		3"		3/4"	93~		89			CD80KR**
				1"	23				B7	
				1-1/4"	25					
8"	2-1/2"	3-1/4"	4000	1-15/16"						CD80QR85
		3-1/2"		3/4"	93~		69			CD80QR**
				1"	24		71P		B8	
				1-1/4"	26					
8"	2-1/2"	3"	4000	3/4"		70			CD80KR70	
8"	3"	3-1/4"	6000	1-15/16"						CD80LR85
		3-1/2"		3/4"	93~		69			CD80LR**
				1"	24		71P		B8	
				1-1/4"	26					
8"	3"	3-1/2"	10000	3/4"		70			CD80LR70	
8"	3"	3-1/2"	10000	1"		71			CD80LR71	
10"	3"	3-1/4"	7000	1-15/16"						CD10LR85
		3-1/2"		3/4"	93~		69			CD10LR**
				1"	24		71P		B8	
				1-1/4"	26					
10"	3"	3-1/2"	10000	3/4"		70			CD10LR70	
10"	3"	3-1/2"	10000	1"		71			CD10LR71	
12"	3"	3-1/4"	8000	1-15/16"						CD12LR85
		3-1/2"		3/4"	93~		69			CD12LR**
				1"	24		71P		B8	
				1-1/4"	26					
12"	3"	3-1/2"	10000	3/4"		70			CD12LR70	
12"	3"	3-1/2"	10000	1"		71			CD12LR71	

~including
spanner
bushing



DROP FORGED STEEL

- Variety of bearing options for optimal performance at different applications
- Temperature range: up to 1,300 °F with bronze bearing
- Drop forged from ASTM1045 high carbon steel
- Tensile strength of 60,000PSI
- Hardness: Rockwell 89-93 B

DURABLE
3 Year
Warranty!

FS12LS74

FS80NX33



FS WHEELS • CAPACITY 20000

Wheel Diameter	Tread Width	Hub Length	Load Capacity	Bore I.D.	Tread Patter(+)	Replace ** with desired bearing code					Part Number
						Roller BRG	Tapered Roller BRG	Prec. Ball BRG	Delrin BRG	Bronze BRG	
4*	2" (Straight-sided)	2"	2500	1-3/16"	Flat						MS40JS84
		2-1/4"		1/2"		92~		12, 56		MS40JS**	
				5/8"		02					
				3/4"		04,09		11, 57	B1, B5		
4"	3"	3-1/4"	6000	1-15/16"	Flat						FS40LS85
		3-1/2"		3/4"		93~		69		FS40LS**	
				1"		24		71P	58		B8
				1-1/4"		26					
5"	2"	2-3/16"	2500	1-3/16"	Flat						FS50JS84
		2-7/16"		1/2"		92~		60	12, 56		FS50JS**
				5/8"		02					
				3/4"		04,09		11, 57	B1, B5		



Wheel Diameter	Tread Width	Hub Length	Load Capacity	Bore I.D.	Tread Pattern(+)	Replace ** with desired bearing code					Part Number
						Roller BRG	Tapered Roller BRG	Prec. Ball BRG	Delrin BRG	Bronze BRG	
6"	2"	2-3/16"	2500	1-3/16"	Flat						FS60JS84
		2-7/16"		1/2"		92~		60	12, 56		FS60JS**
				5/8"		02					
				3/4"		04,09			11, 57	B1, B5	
6"	2"	2-3/16"	8000	45mm	Flat					FS60JS45	
6"	2"	2-7/16"	3000	1/2"	Flat			63			FS60JS63
6"	2"	2-7/16"	3000	3/4"	Flat		70				FS60JS70
6"	2"	2-7/16"	4000	1/2"	Crown			4P			FS60JS4P
6"	3"	3-1/4"	8000	1-15/16"	Flat						FS60LS85
		3-1/2"		3/4"	Flat	93~		69			FS60LS**
				1"	Flat	24		71P	58	B8	
				1-1/4"	Flat	26					
6"	3"	3-1/2"	8000	3/4"	Flat			65			FS60LS65
6"	3"	3-1/2"	12000	3/4"	Flat		79				FS60LS79
6"	3"	3-1/2"	13000	1-1/4"	Flat		74				FS60LS74
6"	3"	3-1/2"	11000	1"	Flat		71	7P			FS60LS**
6"	3"	3-1/4"	9000	2-7/16"	Flat						FS60LS86
		3-1/2"		1"		94~					FS60LS94
				1-1/4"		27					FS60LS27
				1-1/2"		28					FS60LS28
6"	3"	3-1/2"	13000	3/4"	Crown			5P			FS60LX5P
6"	3"	3-1/2"	12000	1"	Crown		71				FS60LX71
8"	2"	2-3/16"	3000	1-3/16"	Flat						FS80JS84
		2-7/16"		1/2"		92~		60	12, 56		FS80JS**
				5/8"		02					
				3/4"		04,09			11, 57	B1, B5	
8"	2"	2-7/16"	3000	1/2"	Flat			63			FS80JS63
8"	2"	2-7/16"	4000	3/4"	Flat		70				FS80JS70
			1/2"			73					FS80JS73
8"	2"	2-7/16"	4000	1/2"	Crown			4P			FS80JX4P
8"	3"	3-1/4"	8000	1-15/16"	Flat						FS80LS85
		3-1/2"		3/4"	Flat	93~		69			FS80LS**
				1"	Flat	24		71P	58	B8	
				1-1/4"	Flat	26					
8"	3"	3-1/4"	9000	2-7/16"	Flat						FS80LS86
		3-1/2"		1"		94~					FS80LS94
				1-1/4"		27					FS80LS27
				1-1/2"		28					FS80LS28
8"	3"	3-1/2"	8000	3/4"	Flat			65			FS80LS65
8"	3"	3-1/2"	8000	3/4"	Flat		79				FS80LS79
8"	3"	3-1/2"	12000	1"	Flat		71				FS80LS71
8"	3"	3-1/2"	12000	3/4"	Crown			5P			FS80LX5P
8"	3"	3-1/2"	12000	1"	Crown		71				FS80LX71
8"	4"	4-1/2"	11000	1-1/4"	Flat			68			FS80NS68
8"	4"	4-1/2"	20000	1-1/4"	Flat			74			FS80NS74
8"	4"	4-1/2"	18000	1"	Crown			7P			FS80NX7P
				1-1/4"				9P			FS80NX9P
10"	3"	3-1/4"	8000	1-15/16"	Flat						FS10LS85
		3-1/2"		3/4"	Flat	93~		69			FS10LS**
				1"	Flat	24		71P	58	B8	
				1-1/4"	Flat	26					
10"	3"	3-1/2"	8000	1"	Flat						FS10LS66
10"	3"	3-1/2"	8000	3/4"	Flat		70				FS10LS70
10"	3"	3-1/2"	12000	1"	Flat		71				FS10LS71
10"	3"	3-1/2"	10000	3/4"	Crown			5P			FS10LX5P
10"	3"	3-1/2"	12000	1"	Crown		71				FS10LX71
10"	4"	4-1/2"	20000	1-1/4"	Flat		74				FS10NS74
10"	4"	4-1/2"	18000	1-1/4"	Flat			8P			FS10NS8P
10"	4"	4-1/2"	18000	1"	Crown			7P			FS10NX7P
10"	4"	4-1/2"	18000	1-1/4"	Crown			8P			FS10NX8P
12"	3"	3-1/2"	12000	1"	Flat		71				FS12LS71
12"	3"	3-1/2"	15000	1-1/4"	Flat		74				FS12LS74
12"	4"	4-1/2"	20000	1-1/4"	Flat		74				FS12NS74

*Machined Solid Steel Straight Sided 4x2 wheel

~including spanner bushing

U-GROOVE WHEEL

- Precisely machined from 1045 Carbon Steel for 1-1/2" to 1-5/8 pipe gauge
- Equipped with sealed precision bearing
- Long lasting lustrous zinc finish
- Temperature range -40°F - 180°F
- Hardness HB220

UG502319



Wheel Daimeter	Tread Width	Hub Length	Load Capacity	Bore I.D.	Groove Width	Groove Depth	Part Number
5"	2-5/16"	2-9/16"	6000	5/8"	1-21/32"	7/8"	UG502319

STAINLESS V-GROOVE WHEEL

- Include stainless sealed precision ball Bearings
- S304 steel machined wheel

TV60JT63

TV50JT63

TV40JT63

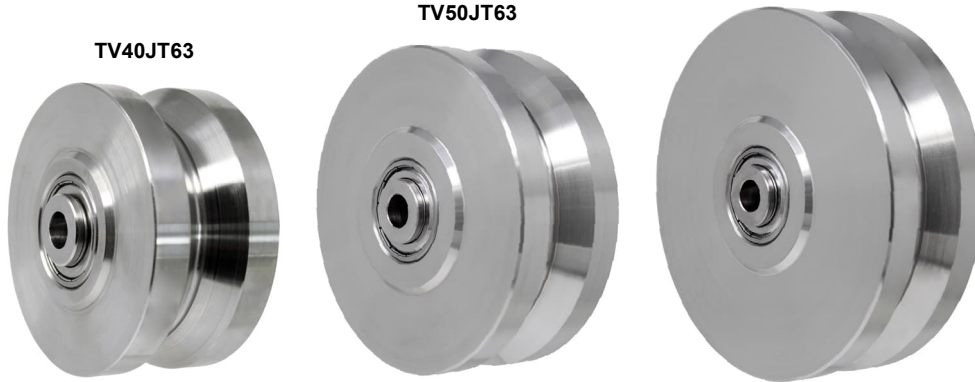

Wheel Daimeter	Tread Width	Hub Length	Load Capacity	Bore I.D.	Groove Width	Part Number
4"	2"	2-7/16"	1500	1/2"	7/8"	TV40JT72
5"	2"	2-7/16"	1600	1/2"	7/8"	TV50JT72
6"	2"	2-7/16"	1800	1/2"	7/8"	TV60JT72

Stainless Solid Steel Wheel

- Include stainless sealed precision ball Bearings
- S304 steel machined wheel

TS40JS63



Wheel Daimeter	Tread Width	Hub Length	Load Capacity	Bore I.D.	Part Number
4"	2"	2-7/16"	1500	1/2"	TS40JS72



MAXROK™ V-GROOVE

- Temperature range -45° F to +250° F
- Durometer Shore D 85 (+/- 5)
- Glass filled nylon molded

MV40HT03

MV40JT60



Wheel Diameter	Tread Width	Hub Length	Load Capacity	Groove Width	Bore I.D.	Replace ** with desired bearings code					Part Number
						Roller BRG	Stainless Roll BRG	Precision Ball BRG	Stainless Pre. Ball BRG	Delrin BRB	
4"	1-1/2"	1-5/8"	600	7/8"	1-3/16"						MV40HT84
		1-7/8"			1/2"	92~	6M	12,56	MV40HT**		
					5/8"	01		11,57			
					3/4"	03					
4"	2"	2-3/16"	800	7/8"	1-3/16"						MV40JT84
		2-7/16"			1/2"	92~	60	6S	12, 56	MV40JT**	
					5/8"	02					
					3/4"	04, 09	05		11, 57		

~including spanner bushing

IRONMAN™ V-GROOVE

- Temperature range: -40°F to 250°F, enduring sharp temperature changes
- Equipped with 6205 Pre. Ball Bearings for its maximum performance
- Compression molded polymer to its maximum strength
- Rust free and smooth in operation
- Durometer: Shore D 78-82

NV60JT4P

NV40JT4P



Wheel Diameter	Tread Width	Hub Length	Load Capacity	Bore I.D.	Groove Width	Part Number
4"	2"	2-7/16"	2200	1/2"	7/8"	NV40JT4P
5"	2"	2-7/16"	2200	1/2"	7/8"	NV50JT4P
6"	2"	2-7/16"	2200	1/2"	7/8"	NV60JT4P
8"	2"	2-7/16"	2200	1/2"	7/8"	NV80JT4P

MV/NV, NV WHEELS • CAPACITY 2200



CAST IRON V-GROOVE

- V-Groove is precisely machined 90°, with relief groove
- Temperature range -45°F to +300°F
- Tensile strength of 30,000 PSI



VG WHEELS • CAPACITY 3500

Wheel Diameter	Tread Width	Hub Length	Load Capacity	Bore I.D.	Groove Width	Replace ** with desired bearing code				Part Number
						Rollger BRG	Sealed Ball BRG	Delrin BRG	Bronze BRG	
3"	1-1/4"	1-5/8"	350	1/2"	7/8"					VG30GT83
3"	1-1/2"	1-5/8"	375	1-3/16"	7/8"					VG30HT84
		1-7/8"		1/2"		92~	6M	12.56		VG30HT**
				5/8"		01				
4"	1-1/2"	1-5/8"	350	3/4"	7/8"			11.57		VG40HT84
		1-7/8"		1-3/16"		92~	6M	12.56		VG40HT**
				1/2"		01				
4"	2"	2-3/16"	600	3/4"	7/8"			11.57		VG40JT84
		2-7/16"		1-3/16"		92~	60	12.56		VG40JT**
				1/2"		02				
5"	2"	2-3/16"	900	5/8"	7/8"			11.57	B1.B5	VG50JT84
		2-7/16"		1-3/16"		92~	60	12.56		VG50JT**
				1/2"		02				
6"	2"	2-3/16"	1000	3/4"	7/8"			11.57	B1.B5	VG60JT84
		2-7/16"		1-3/16"		92~	60	12.56		VG60JT**
				1/2"		02				
6"	2-1/2"	2-3/4"	2500	1-1/4"	7/8"			11.57	B1.B5	VG60KT85
		3"		1-15/16"		93~	89			VG60KT**
				3/4"		23		58	B7	
6"	2-1/2"	3-1/4"	2500	1"	7/8"					VG60QT85
		3"		1-15/16"		93~	69			VG60QT**
				3/4"		24	71P		B8	
6"	3"	3-1/4"	3500	1-1/4"	7/8"					VG60LT85
		3"		1-15/16"		93~	69		B8	VG60LT**
				3/4"		24	71P			
6"	3"	3-1/4"	3500	1"	1-3/8"					VG60LW85
		3"		1-15/16"		93~	69		B8	VG60LW**
				3/4"		24	71P			
8"	2"	2-3/16"	1200	1-1/4"	7/8"					VG80JT84
		2-7/16"		1-3/16"		92~	60	12.56		VG80JT**
				1/2"		02				
8"	2-1/2"	2-3/4"	2500	5/8"	7/8"			11.57	B1.B5	VG80KT85
		3"		1-15/16"		93~	89			VG80KT**
				3/4"		23		58	B7	
8"	2-1/2"	3-1/4"	2500	1"	7/8"					VG80QT85
		3"		1-15/16"		93~	69		B8	VG80QT**
				3/4"		24	71P			
8"	3"	3-1/4"	3500	1-1/4"	7/8"					VG80LT85
		3"		1-15/16"		93~	69		B8	VG80LT**
				3/4"		24	71P			
8"	3"	3-1/4"	3500	1"	1-3/8"					VG80LW85
		3"		1-15/16"		93~	69		B8	VG80LW**
				3/4"		24	71P			
10"	3"	3-1/4"	3500	1-1/4"	7/8"					VG10LT85
		3"		1-15/16"		93~	69		B8	VG10LT**
				3/4"		24	71P			
10"	3"	3-1/4"	3500	1"	1-3/8"					VG10LW85
		3"		1-15/16"		93~	69		B8	VG10LW**
				3/4"		24	71P			

~including spanner bushing



DV WHEELS • CAPACITY 5000

DUCTILE V-GROOVE

- 7/8" Groove width to fit 1" angle iron, 1-3/8" groove width to fit 1-1/2" angle iron
- Made out of Ductile Iron, Extra thick walled, Heavy-duty core, hub and tread
- Variety of bearing options for optimal performance at different application
- Temperature range: -45°F to 800°F (with bronze bearing)
- Precisely machined 90°V-Groove with relief groove
- Tensile Strength of 45,000PSI



Wheel Diameter	Tread Width	Hub Length	Load Capacity	Bore I.D.	Groove Width	Replace ** with desired bearings code					Part Number
						Roller BRG	Tapered Roller BRG	Sealed Ball BRG	Delrin BRG	Bronze BRG	
4"	1-1/2"	1-5/8"	1200	1-3/16"	7/8"			6M	12,56		DV40HT84
		1/2"				03			DV40HT**		
		5/8"		04			11,57				
4"	2"	2-3/16"	1500	1-3/16"	7/8"			60	12,56		DV40JT84
		1/2"		92~							
		5/8"		02							
6"	2"	2-7/16"	1500	3/4"	7/8"				11,57	B1,B5	DV40JT**
		1-3/16"									
		1/2"		92~			60	12,56			
6"	2"	2-7/16"	1500	5/8"	7/8"						DV60JT84
		3/4"		04,09				11,57	B1,B5	DV60JT**	
		1/2"		02			60	12,56			
6"	2"	2-3/16"	1500	1-3/16"	7/8"						DV60JT84
		1/2"		92~			60	12,56			
		5/8"		02							
6"	2"	2-7/16"	1500	3/4"	7/8"				11,57	B1,B5	DV60JT**
		1/2"		04,09							
		2-3/4"				63					
6"	2-1/2"	3"	3500	1-15/16"	7/8"						DV60JT63
		3/4"		93~			89				
		1"		23					B7	DV60KT**	
6"	2-1/2"	3"	3500	1-1/4"	7/8"						DV60KT70
		3/4"		25							
		1"		70							
6"	2-1/2"	3"	3500	1"	7/8"		71				DV60KT71
		3-1/4"									
		1-15/16"									
6"	2-1/2"	3-1/2"	3500	3/4"	7/8"			69			DV60KT85
		1"		93~			89				
		1-1/4"		24			71P		B8	DV60QT**	
6"	2-1/2"	3-1/4"	3500	1"	7/8"						DV60LT85
		1-15/16"		26							
		3/4"		93~			69				
6"	3"	3-1/2"	5000	1"	7/8"			71P		B8	DV60LT**
		1-1/4"		24							
		3/4"		26							
6"	3"	3-1/2"	5000	3/4"	7/8"		70				DV60LT70
		1"		71							
		3-1/4"									
6"	3"	3-1/2"	5000	1-15/16"	1-3/8"						DV60LT71
		3/4"		93~			69				
		1"		24			71P		B8	DV60LW**	
6"	3"	3-1/2"	5000	1-1/4"	1-3/8"						DV60LW70
		3/4"		26							
		1"		70							
6"	3"	3-1/2"	5000	1"	1-3/8"		71				DV60LW71
		3-1/4"									
		1-15/16"									
8"	2-1/2"	3"	3500	3/4"	7/8"						DV80KT85
		1"		93~			89				
		1-1/4"		23					B7	DV80KT**	
8"	2-1/2"	3"	3500	3/4"	7/8"						DV80KT70
		1-15/16"		70							
		3/4"									
8"	2-1/2"	3-1/2"	3500	1"	7/8"						DV80QT85
		3/4"		93~			69				
		1"		24			71P		B8	DV80QT**	
8"	2-1/2"	3"	3500	1-1/4"	7/8"						DV80QT70
		3/4"		26							
		1"		70							
8"	3"	3-1/4"	5000	1-15/16"	7/8"						DV80LT85
		3/4"		93~			69				
		1"		24			71P		B8	DV80LT**	
8"	3"	3-1/2"	5000	1-1/4"	7/8"						DV80LT70
		3/4"		26							
		1"		70							
8"	3"	3-1/2"	5000	1"	7/8"		71				DV80LT71
		3-1/4"									
		1-15/16"									
8"	3"	3-1/2"	5000	3/4"	1-3/8"						DV80LW85
		1"		93~			69				
		1-1/4"		24			71P		B8	DV80LW**	
8"	3"	3-1/2"	5000	1"	1-3/8"						DV80LW70
		3/4"		26							
		1"		70							
10"	3"	3-1/2"	7000	1-15/16"	7/8"						DV80LW71
		3/4"		93~			69				
		1"		24			71P		B8	DV10LT**	
10"	3"	3-1/2"	7000	1-1/4"	7/8"						DV10LT85
		3/4"		26							
		1"		70							
10"	3"	3-1/2"	7000	1"	7/8"		71				DV10LT70
		3-1/4"									
		1-15/16"									
10"	3"	3-1/2"	7000	3/4"	1-3/8"						DV10LW85
		1"		93~			69				
		1-1/4"		24			71P		B8	DV10LW**	
10"	3"	3-1/2"	7000	3/4"	1-3/8"						DV10LW70
		1"		26							
		1-1/4"		70							

~ includes spanner



FORGED AND SOLID STEEL V-GROOVE WHEEL

- 1-3/8" Groove fits 1-1/2" angle iron, 1-3/4" groove fits 1-3/4" to 2" angle iron
- Variety of bearing options for optimal performance at different applications
- Precisely machined 90° V-Groove with relief groove
- Temperature range: up to 1,300° with bronze bearing
- Drop forged from ASTM1045 high carbon steel
- Hardness: Rockwell B 89-93
- Tensile strength of 70,000PSI



FV10LW74

FV80NX33

SV60JI19B

SV40JI14



SV WHEELS • CAPACITY 15000

Wheel Diameter	Tread Width	Hub Length	Load Capacity	Bore I.D.	Groove Width	Replace ** with desired bearing code				Part Number	
						Roller BRG	Tapered Roller BRG	Sealed Ball BRG	Bronze BRG		
4"	1-13/16"	2"	3000	1-3/16"	7/8"					SV40IT84	
				3/4"		36		B1,B5	SV40IT**		
				1/2"			60		SV40JI60		
4"	1-13/16"	2"	3000	1/2"	7/8"			14		SV40JI14	
				5/8"				19		SV40JI19	
6"	1-13/16"	2"	5000	1/2"	7/8"		60	14		SV60JI14	
				5/8"				19		SV60JI19	
6"	1-13/16"	2"	5000	1-3/16"	7/8"					SV60JI84	
				3/4"		04		B1,B5	SV60JI**		
				1/2"			60		SV60JI60		
6"	3"	3-1/4"	7000	1-15/16"	1-3/8"					FV60LW85	
		3-1/2"		3/4"		93~		69	B8	FV60LW**	
				1"		24		71P			
				1-1/4"		26					
6"	3"	3-1/2"	10000	1"	1-3/8"		71			FV60LW71	
				1-1/4"			74			FV60LW74	
				1"				7P		FV60LW7P	
8"	2"	3-1/2"	6000	1-3/16"	1-3/8"					FV80JT84	
				3/4"		04		B1,B5	FV80JT**		
				1/2"				60		FV80JT60	
8"	3"	3-1/2"	10000	3/4"	1-3/8"	36			B1,B5	FV80LW**	
8"	3"	3-1/4"	7000	1-15/16"	1-3/8"						FV80LW85
		3-1/2"		3/4"		93~		69	B8	FV80LW**	
				1"		24		71P			
				1-1/4"		26					
8"	3"	3-1/4"	8000	2-7/16"	1-3/8"						FV80LW86
		3-1/2"		1"		94~			FV80LW**		
				1-1/4"		27					
				1-1/2"		28					
8"	3"	3-1/2"	10000	1"	1-3/8"		71			FV80LW71	
8"	4"	4-1/2"	10000	1-1/4"	1-3/8"		74				FV80NW74
		4-1/4"		1-1/2"	1-3/4"	33					FV80NX33
10"	3"	3-1/2"	12000	1-1/4"	1-3/8"		74				FV10LW74
10"	4"	4-1/4"	15000	1-1/4"	1-3/4"		74				FV10NX74



Single Flanged WHEEL

- Machined flanged and tread for exceptionally low rolling resistance
- Equipped with precision ball bearings, and grease fitting
- Made of different material for a variety of applications

FT: Forged steel machined

Temperature Range -150°F to 1200°F (with bronze bearing)

FC: Cast iron with excellent rolling resistance

Temperature Range -150°F to 600°F (with bronze bearing)

FN: Compressed cast nylon with high impact resistance and best friction resistance, lowest operating noise

Temperature Range -15°F to 175°F

FT35635



FC8L8034



FN6J5012



Wheel Diameter Excluding Flange	Wheel Diameter Including Flange	Wheel width Including Flange	Wheel width Excluding Flange	Hub Length	Load Capacity	Bore I.D.	Part No.	Bearings	Qty of Bearings
A	C	J	K	H					
3 1/2"	4-1/8"	1 7/16"	1 7/8"	2 1/2"	2200	1/2"	FT3J3012	6203	2
4"	5"	1-25/32"	1-13/32"	2-7/16"	3000	1/2"	FC4J504P	6205	2
5"	6"	1-25/32"	1-13/32"	2-7/16"	2000	1/2"	FC5J504P	6205	2
6"	6-7/8"	1-25/32"	1-13/32"	2-7/16"	2500	1/2"	FC6J504P	6205	2
8"	9"	1-25/32"	1-13/32"	2-7/16"	3000	1/2"	FC8J504P	6205	2
8"	9"	3-1/8"	2-11/32"	3-1/2"	6000	3/4"	FC8L805P	6205	4
8"	9"	3-1/8"	2-11/32"	3-1/2"	6000	1"	FC8L8P10	6208	4
3-1/2"	4-1/8"	1-7/16"	1-7/8"	2 7/16"	2200	1/2"	FN3J504P	6205	2
4"	5"	1-25/32"	1-13/32"	2-7/16"	2200	1/2"	FN4J504P	6205	2
5"	6"	1-25/32"	1-13/32"	2-7/16"	2200	1/2"	FN5J504P	6205	2
6"	6-7/8"	1-25/32"	1-13/32"	2-7/16"	2200	1/2"	FN6J504P	6205	2
8"	9"	1-25/32"	1-13/32"	2-7/16"	2200	1/2"	FN8L5P4P	6205	2
8"	9"	3-1/8"	2-11/32"	3-1/2"	5000	3/4"	FN8L8P5P	6205	4
8"	9"	3-1/8"	2-11/32"	3-1/2"	5500	1"	FN8L8P10	6208	4
8"	9"	3-1/8"	2-11/32"	3-1/2"	5500	1-1/4"	FN8L908P	6208	4

FT/FC/FN WHEELS • CAPACITY 6000

FOAM-FILLED PNEUMATIC WHEEL

- Micro-cellular polyurethane foam filled in the tire
- Flat free and excellent wearing resistance

FF6C5TP3

FF0D4OP2



PNEUMATIC WHEELS • CAPACITY 650

Wheel Daimeter	Tire Size/ Type	Load Cap.	Tread Pattern	Ply	Hub Length	Hub Design	Hub type	Bore I.D.	Color Tire/Rim	Bearing Type	Part #
6.2"	2"	200	Saw tooth	4	2-1/2"	Centered	2	1/2"	Black/Zinc	Sealed Ball Bearing	FF60JB60
8.5"	280-4	220	Saw tooth	4	3-3/16"	Centered	3	3/4"	Black/Zinc	Sealed Ball Bearing	FF8A4CP3
10"	4.10/3.50-4	350	Saw tooth	4	4"	Centered	3	3/4"	Black/Zinc	Sealed Ball Bearing	FF0D4CP3
10"	4.10/3.50-4	350	Saw tooth	4	2-1/4"	Offset	3	5/8"	Black/Zinc	Sealed Ball Bearing	FF0D4OP2
10"	4.10/3.50-4	350	Saw tooth	4	2-1/4"	Offset	3	3/4"	Black/Zinc	Sealed Ball Bearing	FF0D4OP3
12"	4.10/3.50-6	500	Saw tooth	4	4"	Centered	1	3/4"	Black/White	Sealed Ball Bearing	FF2D6TP3
12"	4.10/3.50-6	500	Saw tooth	6	4"	Centered	1	3/4"	Black/White	Sealed Ball Bearing	FP2D6TP3
15.4"	4.80/3.50-6	650	Stud	6	3"	Centered	1	3/4"	Black/White	Sealed Ball Bearing	FF6C5TP3

GRAY FOAM-FILLED PNEUMATIC

- Available in zinc, brass and different color coating steel rim
- Butyl rubber inner tube for longer air inflation

FF8F4Y53



Wheel Daimeter	Tire Size/ Type	Load Cap.	Tread Pattern	Ply	Air Pressure	Hub Length	Hub Design	Hub type	Bore I.D.	Color Tire/Rim	Bearing Type	Part #
8.5"	280-4	220	Saw tooth	4	50	3-3/16"	Centered	3	3/4"	Gray/Zinc	Sealed Ball Bearing	FF8A4Y53
9"	280-4	220	Saw tooth	4	50	3-3/16"	Centered	3	3/4"	Gray/Zinc	Flanged Ball Bearing	FF8G4Y53
10"	4.10/3.50-4	350	Saw tooth	4	50	4"	Centered	3	3/4"	Gray/Zinc	Flanged Ball Bearing	FF0D4Y53



GRAY PNEUMATIC

- Available in zinc, brass and different color coating steel rim
- Butyl rubber inner tube for longer air inflation

FP5B4Y53

FP0D4Y53



Wheel Daimeter	Tire Size/ Type	Load Cap.	Tread Pattern	Ply	Air Pressure	Hub Length	Hub Design	Hub type	Bore I.D.	Color Tire/Rim	Bearing Type	Part #
8.5"	250-4	220	lug	4	50	3"	Centered	3	1-3/8"	Gray/Zinc		FP5B4Y95
						3-1/4"			1/2"	Gray/Zinc	Sealed Ball Bearing	FP5B4YP1
									5/8"	Gray/Zinc	Sealed Ball Bearing	FP5B4YP2
									3/4"	Gray/Zinc	Sealed Ball Bearing	FP5B4YP3
8.5"	280-4	220	Saw tooth	4	50	3-3/16"	Centered	3	3/4"	Gray/Zinc	Sealed Ball Bearing	FP8A4Y53
9"	280-4	220	Saw tooth	4	50	3-3/16"	Centered	3	3/4"	Gray/Zinc	Flanged Ball Bearing	FF8F4Y53
9"	280-4	220	Saw tooth	4	50	2-1/4"	Offset	3	1/2"	Gray/Zinc	Flanged Ball Bearing	FF8F4D51
9"	280-4	220	Saw tooth	4	50	3-3/16"	Centered	3	3/4"	Gray/Brass	Sealed Ball Bearing	FP8F4FP3
10"	4.10/3.50-4	350	Saw tooth	4	50	4"	Centered	3	3/4"	Gray/Zinc	Flanged Ball Bearing	FP0D4Y53

BLACK POLYURETHANE FILLED PNEUMATIC

- Polyurethane resin is pumped into pneumatic tire to replace air with a resilient
- Powder coated steel rim

FU80WC38



Wheel Daimeter	Tire Size/ Type	Load Cap.	Tread Pattern	Ply	Hub Length	Hub Design	Rim	Bore I.D.	Color Tire/Rim	Bearing Type	Part #
8.5"	280-4	220	Saw tooth	4	3-3/16"	Centered	1	3/4"	Black/white	Sealed Ball Bearing	FU8A4CP3
										Roller Bearings	FU8A4C38
10"	4.10/3.50-4	350	Saw tooth	4	4"	Centered	1	3/4"	Black/white	Flanged Ball Bearing	FU0D4CP3
										Roller Bearings	FU0D4C40



BLACK PNEUMATIC

- Available in zinc, brass and different color coating steel rim
- Butyl rubber inner tube for longer air inflation



PNEUMATIC WHEELS • CAPACITY 650

Wheel Dai	Tire Size/Type	Load Cap.	Tread Pattern	Ply	Air Pressure	Hub Length	Hub Design	Hub type	Bore I.D.	Color-Tire/Rim	Bearing Type	Part #
6.2"	2"	200	Sawtooth	4	30	2-1/2"	Centered	2	1/2"	Black/Zinc	Sealed Ball Bearing	FP60JB60
6.2"	2"	200	Sawtooth	4	30	2-1/4"	Offset	2	1/2"	Black/Zinc	Sealed Ball Bearing	FP60JO60
8.5"	250-4	220	lug	4	50	2-1/2"	Centered	3	3/4"	Black/Zinc	Sealed Ball Bearing	FP5B1CP3
											Flanged Ball Bearing	FP5B1C53
8.5"	280-4	220	Sawtooth	4	50	3-3/16"	Centered	3	1/2"	Black/Zinc	Flanged Ball Bearing	FP8A4C51
								1/2"	Sealed Ball Bearing		FP8A4CP1	
								5/8"	Sealed Ball Bearing		FP8A4CP2	
								3/4"	Sealed Ball Bearing		FP8A4CP3	
8.5"	284-4	220	Sawtooth	4	50	3-3/16"	Centered	3	3/4"	Black/Brass	Sealed Ball Bearing	FP8F4FP3
9"	280-4	250	Sawtooth	4	50	3-3/16"	Centered	3	1-3/8"	Black/Zinc	Plain bore	FP8F4C95
								1/2"	Sealed Ball Bearing		FP8F4CP1	
								3/4"	Sealed Ball Bearing		FP8F4CP3	
								3/4"	Roller		FP8F4C38	
9"	280-4	250	Sawtooth	4	50	2-1/4"	Offset	3	5/8"	Black/Zinc	Sealed Ball Bearing	FP8F4OP2
9"	280-4	250	Sawtooth	4	50	2-1/4"	Offset	3	5/8"	Black/Brass	Sealed Ball Bearing	FP8F4OP2
10"	4.10/3.50-4	350	Sawtooth	4	50	4"	Centered	3	1/2"	Black/Zinc	Flanged Ball Bearing	FP0D4C51
								3/4"	Flanged Ball Bearing		FP0D4C53	
								3/4"	Sealed Ball Bearing		FP0D4CP3	
								3/4"	Roller		FP0D4C40	
10"	4.10/3.50-4	350	Sawtooth	4	50	2-1/4"	Offset	3	1-3/8"	Black/Zinc	Plain bore	FP0D4O95
								5/8"	Flanged Ball Bearing		FP0D4O52	
								3/4"	Flanged Ball Bearing		FP0D4O53	
								1/2"	Sealed Ball Bearing		FP0D4OP1	
								5/8"	Sealed Ball Bearing		FP0D4OP2	
								3/4"	Sealed Ball Bearing		FP0D4OP3	
10"	4.10/3.50-4	350	Sawtooth	4	50	1.85"	Centered	3	5/8"	Black/Zinc	Sealed Ball Bearing	FP0D4SP2
10"	4.10/3.50-4	350	Sawtooth	4	50	2-1/4"	Offset	1	5/8"	Black/White	Flanged Ball Bearing	FP0D4W52
10.4"	4.10/3.50-4	350	Sawtooth2	4	50	2-1/4"	Offset	1	5/8"	Black/Almond	Sealed Ball Bearing	FP0E4E52
10"	4.10/3.50-4	350	Sawtooth	4	50	3-1/4"	Centered	1	1-3/8"	Black/Gray	Sealed Ball Bearing	FP0D4K95
								1/2"	Sealed Ball Bearing		FP0D4KP1	
								5/8"	Sealed Ball Bearing		FP0D4KP2	
								3/4"	Sealed Ball Bearing		FP0D4KP3	
10"	4.10/3.50-4	500	Sawtooth	4	50	2-1/4"	Offset	3	1-3/8"	Black/Zinc	Plain bore	FP0H4O95
								1/2"	Sealed Ball Bearing		FP0H4OP1	
								5/8"	Sealed Ball Bearing		FP0H4OP2	
								3/4"	Sealed Ball Bearing		FP0H4OP3	
10"	4.10/3.50-4	500	Sawtooth	4	50	4"	Centered	3	1-3/8"	Black/Zinc	Plain bore	FP0H4C95
								1/2"	Sealed Ball Bearing		FP0H4CP1	
								5/8"	Sealed Ball Bearing		FP0H4CP2	
								3/4"	Sealed Ball Bearing		FP0H4CP3	
10"	4.10/3.50-4	350	Knobby	4	50	4"	Centered	1	3/4"	Black/Black	Sealed Ball Bearing	FP0P4CP3
10"	4.10/3.50-4	350	Knobby	4	50	4"	Offset	1		Black/White	Sealed Ball Bearing	FP0P4OP2
11.75"	13x6.5-6	320	Ribbed	4	30	3-1/4"	Offset	1	5/8"	Black/White	Sealed Ball Bearing	FP13R4P2
12"	4.10/3.50-6	500	Sawtooth	6	85	4"	Centered	1	3/4"	Black/White	Sealed Ball Bearing	FP2D6TP3
12"	4.10/3.50-6	500	Sawtooth	6	85	3-1/4"	Offset	1	3/4"	Black/Gray	Sealed Ball Bearing	FP2D6OP3
15.4"	4.80/3.50-6	650	Stud	6	50	3"	Centered	1	3/4"	Black/White	Sealed Ball Bearing	FP6C6TP3



EVER-ROLL™

- Available in Black and Gray tire, Zinc and Brass plated rim
- Made from closed cell Micro-cellular polyurethane foam
- Available in 3-pcs and 1-pcs metal hub
- Flat-Free and smooth cushioned ride
- Sawtooth tread

ER WHEELS • CAPACITY 520



Wheel Diameter	Tire Width	Hub Length	Hub Design	Load Capacity	Color	Tire Pattern	Rim Design	Bore I.D.	Replace ** with desired bearing code			Part #
									Roller BRG	Ball BRG	Sealed Ball BRG	
6"	2"	2-1/4"	Centered	150	Black/Zinc	Saw Tooth	2	1/2"		60		ER60JB60
6"	2"	2-1/4"	Centered	150	Gray/Zinc	Saw Tooth	2	1/2"		60		ER60JI60
6.25"	3"	3"	Centered	150	Black/White	Saw Tooth	2	3/4"	38			ER60LW38
8.1"	2"	2-3/8"	Centered	275	Black/Zinc	Saw Tooth	2	1/2"		51		ER80JB51
								5/8"		52		ER80JB52
								3/4"		53		ER80JB53
8"	3"	3-3/16"	Centered	275	Black/Gray	Saw Tooth	Plastic	3/4"		53		ER80CT53
8"	3"	3-3/16"	Centered	275	Black/Black	Saw Tooth	Plastic	1-3/8"				ER80CL95
								1/2"		51	P1	ER80CL**
								5/8"		52	P2	
								3/4"		53	P3	
8.9"	2-15/16"	3"	Centered	250	Black/Zinc	Saw Tooth	3	1-3/8"				ER80BC95
		3-3/16"						1/2"		51	P1	ER80BC**
								5/8"		52	P2	
								3/4"		53	P3	
8.9"	2-15/16"	3"	Centered	250	Gray/Zinc	Saw Tooth	3	1-3/8"				ER80GC95
		3-3/16"						1/2"		51	P1	ER80GC**
								5/8"		52	P2	
								3/4"		53	P3	
8.9"	2-15/16"	2-1/4"	Offset	250	Black/Zinc	Saw Tooth	3	5/8"		52	P2	ER80BO**
8.5"	2-1/2"	3-1/8"	Centered	250	Black/Zinc	Saw Tooth	3	3/4"		53		ER8ABC53
10.2"	3-1/8"	4"	Centered	280	Black/Zinc	Saw Tooth	3	1/2"		51	P1	ER10BC**
								3/4"		53	P3	
								1-3/8"				
10.2"	3-7/16"	2"	Offset	280	Black/Gray	Saw Tooth	1	5/8"			P2	ER10BOP2
10.2"	3-1/8"	2-1/4"	Offset	280	Black/Zinc	Saw Tooth	3	5/8"			P2	ER10BOP2-3
10.2"	3-1/8"	2-1/4"	Offset	280	Black/Zinc	Saw Tooth	3	3/4"			P3	ER10BOP3
10.5"	3-1/4"	3-1/4"	Centered	280	Black/Gray	Saw Tooth	Plastic	3/4"		53		ER10CT53
10.2"	3-1/8"	4"	Centered	280	Black/White	Saw Tooth	1	1/2"			P1	ER10CWP1
10.2"	3-1/8"	4"	Centered	280	Black/White	Saw Tooth	1	5/8"		52		ER10CW52
10.2"	3-1/8"	4"	Centered	280	Black/White	Saw Tooth	1	3/4"			P3	ER10CWP3
10.5"	3-1/4"	2-1/4"	Offset	280	Black/Gray	Saw Tooth	Plastic	5/8"		52	P2	ER10OT**
12"	1-3/4"	2-3/8"	Centered	150	Black/Black	Smooth	Plastic	1/2"		51		ER12IB51
12"	2-1/2"	2"	Centered	300	Black/Black	Stud	Plastic	1/2"			PB12	ER12KBPB12
11.75"	5"	5"	Centered	400	Black/White	Turf	1	5/8"		52		ER13BC52
13"	5"	5"	Centered	400	Black/White	Sawtooth	1	5/8"		52		ER13CWP3
15.5"	3-3/4"	3"	Centered	520	Black/White	Rib	1	3/4"			P3	ER16BCP3
16"	3-3/4"	3"	Centered	520	Black/White	Stud	1	3/4"			P3	ER16BBP3

*The Ever-Roll is not designed to sit with load.

1 = 1-PC welded
2 = 2-PC Bolt together
3 = 3-PC bolt together



ELASTORIDE™

- Balloon cushion rubber press on polyolefin core
- Light weight while excellent impact resistance
- Temperature range -40° F to +180° F
- Offset Hub for easy installation
- Non-marking Black or Gray tire
- Never deflate
- Shore A 75-80



RT,SN WHEELS • CAPACITY 300

Wheel Diameter	Tread Width	Offset Hub Length	Load Capacity	Bore I.D.	Color (tire/core)	Replace ** with Bearing Code		Part Number
						Flanged Ball BRG	Sealed Ball BRG	
8"	2"	2-1/4"	250	1-3/8"	Gray/Gray			RT80JI95
				1/2"		51	P1	RT80JI**
				5/8"		52	P2	
				3/4"		53	P3	
8"	2"	2-1/4"	250	1-3/8"	Black/Gray			RT80JZ95
				1/2"		51	P1	RT80JZ**
				5/8"		52	P2	
				3/4"		53	P3	
10"	2"	2-1/4"	300	1-3/8"	Gray/Gray			RT10JI95
				1/2"		51	P1	RT10JI**
				5/8"		52	P2	
				3/4"		53	P3	
10"	2"	2-1/4"	300	1-3/8"	Black/Gray			RT10JZ95
				1/2"		51	P1	RT10JZ**
				5/8"		52	P2	
				3/4"		53	P3	
10"	2"	2-1/4"	300	1-3/8"	Black/Black			RT10JB95
				1/2"		51	P1	RT10JB**
				5/8"		52	P2	
				3/4"		53	P3	

SEMI-PNEUMATIC with Metal Hub

- Zero pressure tire pressed in a bolted steel rim
- Temperature range: -20° F to 200° F
- Durometer: Shore A 80(+/- 5)

SN80HO52



Wheel Diameter	Tread Width	Hub Length	Hub Design	Weight Capacity	Bore I.D.	Hub Color	Part #
8"	1-5/8"	1-17/64"	Offset	350	5/8" (steel Insert)	GRAY-PLASTIC	SN80HOM2
10"	1-3/4"	2"	Offset	150	1/2"	Tin	SN10EM51
10"	2-3/4"	3-1/16"	Center	550	3/4"	Zinc	SN10UTP3
10"	2-3/4"	2-1/4"	Offset	550	5/8"	Zinc	SN10UMP2
10"	2-3/4"	2-1/4"	Offset	550	3/4"	Zinc	SN10UMP3



ECO-RUBBER™

- Temperature Range -20°F to +160° F (Intermittent -40°F to +212° F)
- Wide and soft tread is ideal for rolling on grass and dirt, etc...
- High-Impact resistance polymer core
- Solid rubber tread

SN WHEELS • CAPACITY 850



Wheel Diameter	Tread Width	Hub Length	Hub Design	Load Capacity	Bore I.D.	Replace ** with desired bearing code		Part Number
						Flanged Ball BRG	Sealed Ball BRG	
6"	2"	2-1/2"	Centered	350	1/2"	51		SN60JB51
					5/8"	52		SN60JB52
					3/4"	53		SN60JB53
7"	2"	2-1/4"	Centered	400	3/4"	53		SN70UC53
8"	2"	2-1/8"	Offset-waffle	450	1/2"		P1	SN80COP1
					5/8"		P2	SN80COP2
					5/8"		P3	SN80CO52
8"	2-1/4"	2-1/2"	Centered	450	1/2"	51		SN80UC51
					5/8"	52		SN80UC52
					3/4"	53	P3	SN80UC**
8"	2-1/4"	2-1/4"	Offset	450	1/2"	51	P1	SN80UO**
					5/8"	52	P2	
					3/4"	53	P3	
10"	2"	1-5/8"	Offset	500	5/8"	52		SN10JN52
10"	2"	2-1/4"	Centered	500	5/8"	52		SN10JC52
					3/4"	53		SN10JC53
10"	2-3/4"	3-1/4"	Centered	650	1/2"		P1	SN10UC**
					5/8"	52		
					3/4"	53	P3	
10"	2-3/4"	2-1/4"	Offset	650	1/2"		P1	SN10UO**
					5/8"	52	P2	
					3/4"	53	P3	
12"	3"	3-1/4"	Centered	850	1-3/8"			SN12LC95
					5/8"	52	P2	SN12LC**
					3/4"	53	P3	
12"	3"	2-3/4"	Offset	850	1-3/8"			SN12LO95
					1/2"		P1	SN12LO**
					5/8"		P2	
					3/4"	P3	P3	

BOGEY & NOSE ROLLERS

BOGEY WHEEL:

- Carbon steel axle is drilled, cross drilled and includes a recessed zerk fitting
- Manufactured from schedule 40 pipe with strong steel tubing
- Weld to 1/4" thick end plates

NOSE ROLLER:

- Carbon Steel axle is drilled, cross-drilled and include a recessed zerk fitting
- Fully machined semi-steel roller, concentric with the axle



Part Number	Dimensions	Axle Dimensions
BR0404	4" Dia x 4-1/2"	1-1/2" x 6-1/4"
BR0406	4" Dia x 6"	1-1/2" x 8-1/4"
BR1008	10-3/4" Dia x 8"	1-1/2" x 10-1/2"
BR0808	8-5/8" Dia x 8"	1-1/2" x 10-1/2"

PALLET JACK WHEELS

- Polyurethane tread chemically bonded to heavy duty iron core
- Equipped with 6204 sealed precision ball bearing. 20mm ID
- Temperature range: -40° F to +180° F
- Durometer: Shore D 65(+/-5)

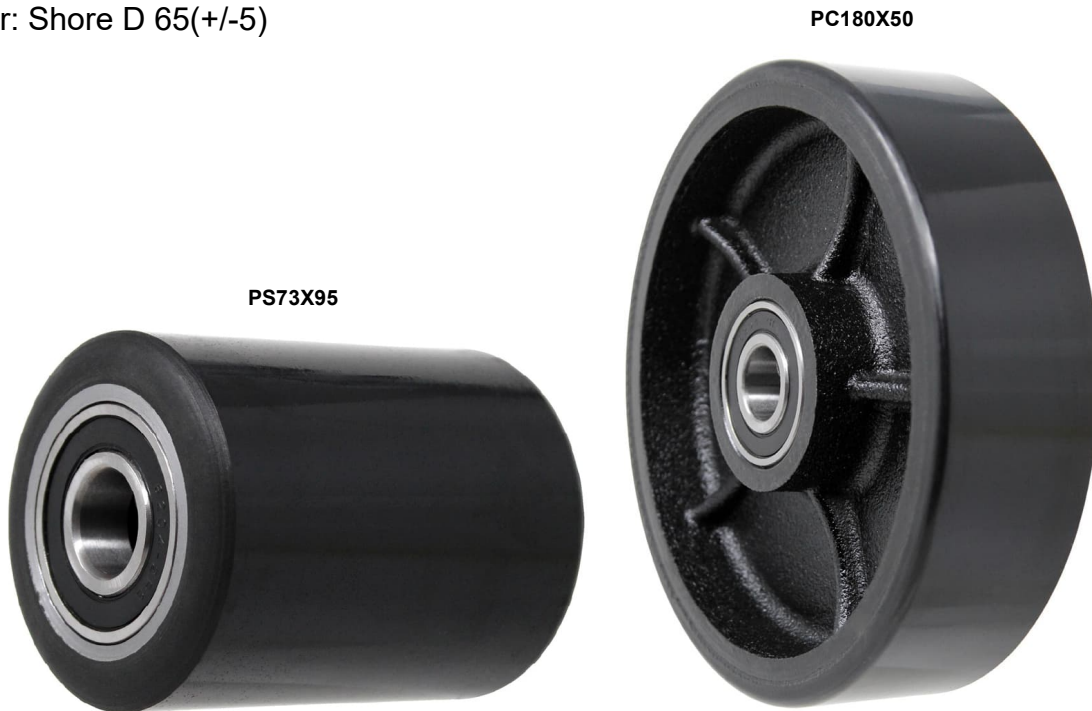

Part #	Diameter	Hub Length	I.D.	Tread Length	Load Capacity
PC180X50	180mm	1.76"	20mm	50mm	1900lb
PS73X95	73mm	3.70"	20mm	95mm	1300lb

DURABLE U.S.A. INC.
Corporate Office: 2801 E. Abram St., Arlington, TX 76010

800-848-4517 (phone) 972-206-0950 (fax)

Sales: [info@durableusa.com](mailto:info@ durableusa.com)
Engineering Support: engineer@durableusa.com



WWW.DURABLEUSA.COM